

famatel

USA

products for a better life



EASY LIFE

TECH

Clever Products for Clever Homes



Authorized dealer - Distribuidor autorizado

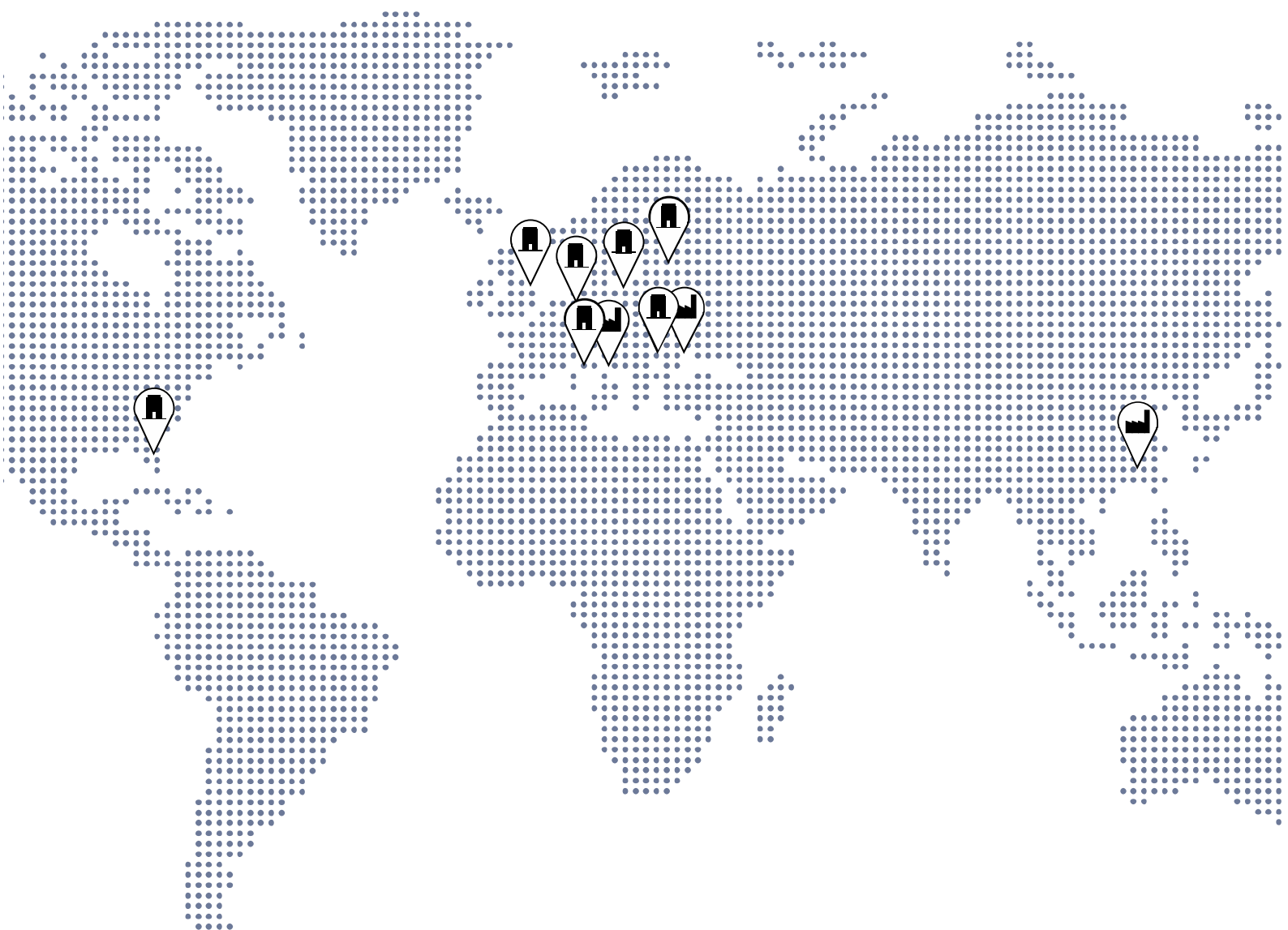

 **Famatel filiales**
Famatel subsidiary

 **Famatel fábricas**
Famatel factories

PENSAMOS Y ACTUAMOS DE MANERA GLOBAL WE THINK AND ACT GLOBALLY

25 years

Famatel is company with more than 25 years of experience in the manufacture of electrical hardware.

Creer en este proyecto nos ha permitido hacerlo realidad traspasando fronteras. Nos hemos convertido en una empresa global donde las personas, su actitud y su conocimiento forman el eje vertebrador del proyecto Famatel.

Nuestra estrategia corporativa, apoyada en los pilares del trabajo en equipo y el respeto a la diversidad, nos ha proyectado a estar presentes en más de 60 países con 3 centros de producción y 7 filiales propias.

Un equipo autoexigente, honesto y muy motivado se esfuerza cada día para consolidar nuestro posicionamiento en el mercado nacional e internacional fortaleciendo nuestras relaciones con clientes y proveedores.

55 MM

Famatel Group made a 55 Million USD turnover last year.

By believing in this project we've truly crossed borders. We've become a global business where people, their attitude and their knowledge are the backbone to the Famatel project.

Our corporate strategy rests on the pillars of teamwork and respect for diversity; it's led us to have a presence in over 60 countries with 3 production centers and 7 subsidiaries.

A demanding, honest and well-motivated team strive every day to consolidate our position on the national and international market by strengthening our relationship with clients and

60 countries

We supply to more than 60 countries around the globe.



Headquarter Famatel Spain



Subsidiary Famatel USA

I+D+I
R&D&I

Para alcanzar la excelencia investigamos, trabajamos y descubrimos. En definitiva, innovamos. Porque la innovación es lo que nos hace diferentes y nos conecta con el consumidor.

In order to achieve excellence, we are dedicated to carrying out research, working hard and making discoveries. In short, we innovate. Innovation is what sets us apart and makes us connect with the consumer.

PRODUCCIÓN
PRODUCTION

Para ofrecer productos de un alto valor añadido y garantizar un servicio rápido y eficaz a la demanda del mercado aplicamos un equilibrio entre la flexibilidad y la especialización. Damos respuesta a las necesidades del mercado nacional e internacional con nuestros más de 3.000 productos estándar y sus múltiples variables.

To offer high value-added products and guarantee a quick and effective service that meets the demands of the market, we apply a balance between flexibility and specialization. We meet the needs of the national and international market with more than 3000 standard products and their multiple variables.

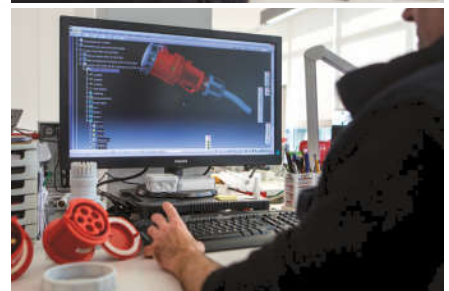

LA CALIDAD ES NUESTRA PRIORIDAD QUALITY IS OUR PRIORITY

Una parte muy importante de nuestra política empresarial está basada en establecer y mantener un efectivo y eficiente Programa de Calidad presente en todos los procesos y ámbitos de la empresa.

El sistema integrado de Gestión de Calidad Famatel se basa en los requisitos de la norma UNE-EN ISO 9001: 2008, así como en otras normas nacionales e internacionales aplicables. Su cumplimiento está liderado por la Alta Dirección y responde al compromiso de toda la organización.

An important part of our business policy is based on establishing an effective and efficient Quality Program that is built into all of our business' processes and departments.

The integrated Famatel Quality Management System is based on the requirements of UNE-EN ISO 9001:2008, as well as other applicable national and international standards. Compliance is headed up by our Senior Management, and is part of the whole organization's commitment.



Aseguramos el cumplimiento de las normativas nacionales e internacionales de todos los productos fabricados por Famatel. Nuestro departamento de I+D+i, a través de nuestros propios laboratorios y en colaboración con entidades certificadoras, garantiza la realización de todos los ensayos necesarios que avalan la calidad de nuestros productos y el cumplimiento de las normativas vigentes.

We guarantee compliance with national and international standards for all products manufactured by Famatel. Our R&D&I department uses its many internal labs, collaborating with certifying agencies, to guarantee all necessary trials are carried out to vouch for the quality of our products and compliance with the current standards.

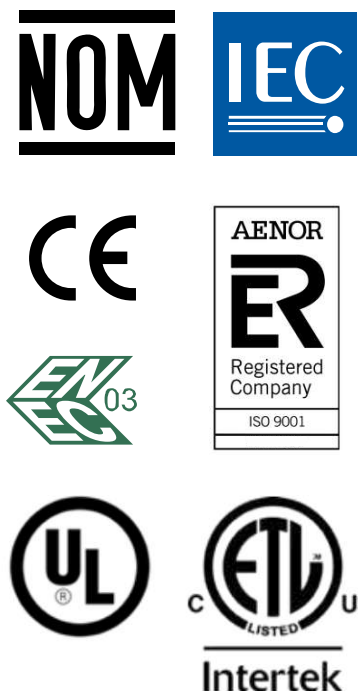

Sólo mediante la combinación de materias primas de primera calidad y procesos de fabricación avanzados se garantiza la obtención de un producto superior. Y por ello utilizamos únicamente granulados de primer nivel que son procesados por un equipo de trabajadores altamente cualificados en nuestras plantas de producción de última generación para crear productos FAMATEL con calidad certificada.

Uno de los termoplásticos industriales más utilizados en nuestros procesos de fabricación es el ABS por su gran tenacidad, incluso a baja temperatura. Además, es duro y rígido, tiene una resistencia química aceptable, baja absorción de agua, y por lo tanto buena estabilidad dimensional, y alta resistencia a la abrasión.

Only by combining premium quality raw materials and advanced manufacturing processes is it possible to obtain a superior product. And for that reason we use only first level granules that are processed by a team of highly qualified workers in our state-of-the-art production plants to create FAMATEL products with certified quality.

One of the industrial thermoplastics most used in our manufacturing processes is ABS due to its great tenacity, even at low temperature. In addition, it is hard and rigid, has an acceptable chemical resistance, low water absorption, and therefore good dimensional stability, and high resistance to abrasion.



Magna

ARMARIOS ESTANCOS TERMOPLÁSTICOS IP65 WATERTIGHT ENCLOSURES IP65

MAGNA está formada por 6 modelos hasta una medida máxima de 800x600. Pensadas para su aplicación en el sector residencial e industrial por su versatilidad y grado de protección a los agentes externos. Incorporan una placa metálica que permite la instalación de cualquier equipo eléctrico y de control. Destaca la posibilidad de incorporar un equipo porta módulos así como la instalación de una segunda puerta de seguridad. Su sistema de apertura por llave triangular permite un rápido y fácil acceso al interior de la instalación.

MAGNA is composed for 6 models up to a maximum measurement of 800x600. Designed for application in the residential and industrial sector for its versatility and degree of protection to external agents. Incorporate a metal plate that allows the installation of any electrical and control equipment. It emphasizes the possibility of incorporating a porta-modules as well as the installation of a second security door. Its system of opening by triangular key allows a quick and easy access to the interior of the installation.





- Marco y puerta en **ABS**
- Sistema de cierre 1/4 de giro
- **Incluye placa metálica galvanizada**

- Door and base in **ABS**
- 1/4 turn plastic key
- **Galvanized metallic plate included**



Características/ advantages

IP65
 Fabricado en **ABS** / *made in ABS thermoplastic.*
 Alta Resistencia al impacto IK-08 / *High impact resistance IK-08*
 Incluye Placa Metálica Galvanizada / *Included mounting galvanized metal*
 Protección a la corrosión, salitre y UV / *Protected against corrosion, salinity and UV.*



Ref.	39123	39134	39145
	210x280x130 mm 8"17/64 x 11"1/32 x 5"1/8	300x400x165 mm 11"13x15"3/4 x 6"1/2	400x500x175 mm 15" 3/4x19"11/16x 6" 57/64



Ref.	39146	39157	39168
	400x600x200 mm 15"3/4 x 23"5/8 x 7"7/8	700x500x245 mm 27"9/16 x 19"11/16 x 9"41/64	800x600x260 mm 31"1/2 x 23"5/8 x 10"15/64



39120 (para/for 39146/39157/39168)
 Cerradura bombín / *optional lock*

39122 (para/for 39123/39134/39145)
 Cerradura bombín / *optional lock*



39119 Fijación a pared / *Wall fixation*
 (Para/for 39123/39134/39145)



I-39123 / I-39134 / I-39145 / I-39146 / I-39157
 Estructura de railes DIN / *Rail DIN structure*
 (Para/for 39123/39134/39145/39146/39157)



Características/ advantages

Nema Type 4X

Fabricado en **PC** / made in **PC thermoplastic**.

Protección a la corrosión, salitre y UV / Protected against corrosion, salinity and UV.

Material libre de halógenos / Halogen free materials

Tensión de aislamiento / Isolation voltage: 1000 VAC / 1500 VDC



Ref. **39123UL**

210x280x130 mm
 8"17/64 x 11"1/32 x 5"1/8

Ref. **39134UL**

300x400x165 mm
 11"13x15"3/4 x 6"1/2



Ref. **39145UL**

400x500x175 mm
 15" 3/4x19"11/16x 6" 57/64

Ref. **39146UL**

400x600x200 mm
 15"3/4 x 23"5/8 x 7"7/8

**Built-in components /
 Componentes
 incorporados**

Galvanized metal plate
 0,8mm
*Placa metálica galvanizada
 0,8mm*

Metal plate supports + screws
*Soportes placa metálica +
 tornillos*

Caps
Tapones

Triangular Key
Llave triangular



39120 (para/for 39146UL)
 Cerradura bombín / optional lock



39122 (para/for 39123UL/39134UL/39145UL)
 Cerradura bombín / optional lock



39119 Fijación a pared / Wall fixation
 (Para/for 39123UL/39134UL/39145UL)



I-39123 / I-39134 / I-39145 / I-39146
 Estructura de railes DIN / Rail DIN structure
 (Para/for 39123UL/39134UL/39145UL/39146UL)

Watertight ASA Board

Armario estanco fabricado en ASA

ARMARIO ESTANCO FABRICADO EN ASA / WATERTIGHT ASA BOARD

BOX 39169



Características/ Advantages

Fabricado en **ASA** / made of **ASA** (Acrylonitrile Styrene Acrylate)

Para uso en aplicaciones exteriores y resistencia ultravioleta / Usage for outdoor applications and for high ultraviolet resistance

Resistente a UV / Resistant to UV

Sistema triple de cerradura / Triple lock system

IK 10

RAL 9011 - Beige

Temperatura de trabajo: -25 a 80°C / Operating temperature: -25 to 80°C

Material PUR para sellado de alta calidad / PUR Material for high quality sealing

Incluye una placa de montaje galvanizada de 1 mm / Included 1 mm galvanized mounting plate



Armario / Cabinet

Ref.	Dimensions	N° locks	Pack
39169	750x1000x300 mm Triple lock system	1	1

Techo / Roof

Ref.	Dimensions	N° locks	Pack
39169R			1

Base

Ref.	Dimensions	N° locks	Pack
39169B			1

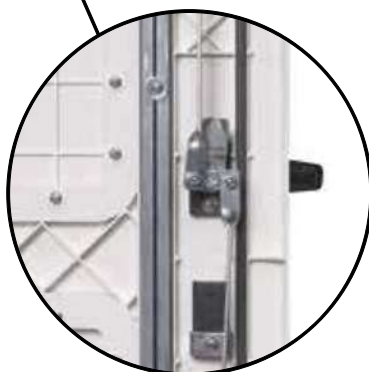

Sistema triple de cerradura / Triple lock system

Nuevo concepto de cajas estancas compuesto por más de 42 modelos para cubrir todas las necesidades de instalación. Fabricadas en material termoplástico de alta resistencia al impacto, protección de rayos ultravioletas y libres de halógenos. Estas cajas con un grado de protección IP55 garantizan una perfecta estanqueidad en cualquier tipo de instalación. El nuevo diseño de los conos permite asegurar el grado de estanqueidad entrando directamente con el cable sin necesidad de utilizar el tubo de instalación rígido.

A new concept of sealed boxes composed by 42 models covering all installation needs. They are made of thermoplastic material with high resistance to impact, protection against the UV and halogen free. These boxes with an IP55 protection degree are ready to be used in any kind of installation. The new design of the cones guarantees the IP55 degree with a direct cable entry without the need to use a rigid tube.



Cono métrico
Metric cones



Precintable
Sealable

Sujección puerta
Door hinge

Tornillo 1/4 vuelta
1/4 turn screw



- Tapa y base en **ABS**
- Cierre tapa a presión
- Conos para entrada directa de cable

- Cover and base in **ABS**
- Press cover
- Cones allowing the direct entry of the cables



AcquaBOX
Cierre tapa a presión
Press cover



Ref.	3027	3028	3003	3011
Entradas/Entries	-	-	-	7-Ø25 mm
Dim	Ø70 mm 6,7" x 3,93" x 4,12"	80x80x45 mm 3"35/64 x 3"35/64 x 1"21/32	100x100x45 mm 3"15/16 x 3"15/16" x 1"49/64	100x100x55 mm 3"15/16 x 3"15/16 x 2"11/64

AcquaBOX
Cierre por tornillo 1/4 de vuelta
1/4 turn screw

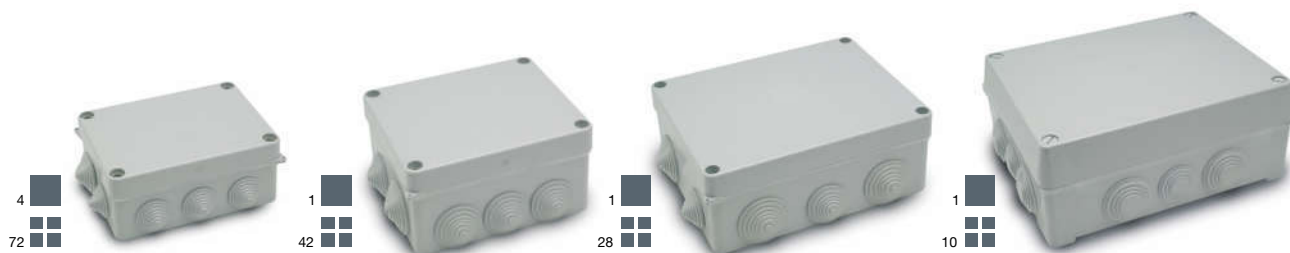

Ref.	3012	3013	3014	3015
Entradas/Entries	8-Ø25 / 2-Ø32 mm	8-Ø31 / 2-Ø40mm	6-Ø40 / 4-Ø32mm	4-Ø40 / 8-Ø50mm
Dim	110x152x63 mm 4"21/64x 5"63/64 x 2"31/64	135x161x83 mm 5"5/16 x 6"11/32 x 3"17/64	175x225x85 mm 6"57/64 x 8"55/64 x 3"11/32	310x240x125 mm 12"13/64 x 9"29/64 x 4"59/64

Accesorios
Accessories





- Marco y base en ABS
- Frame and base in ABS



miniBOX

Cierre tapa a presión
Press cover

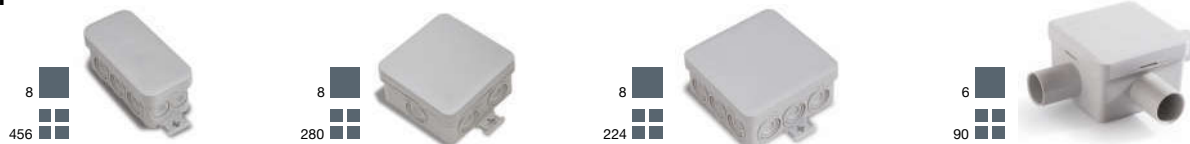

Ref.	3050	3051	3052	3056 / 3059
Entradas/Entries	10-Ø19 (0,75")	7-Ø19 (0,75")	10-Ø19 (0,75")	4-Ø16/20 - 4-Ø20/25
Dim	90x43x39 mm 3"35/64 x 1"11/16 x 1"17/32	75x75x39 mm 2"61/64 x 2"61/64 x 1"17/32	85x85x39 mm 3"11/32 x 3"11/32 x 1"17/32	75x75x39 mm 2"61/64 x 2"61/64 x 1"17/32

AcquaBOX

Cierre tapa a presión
Press cover

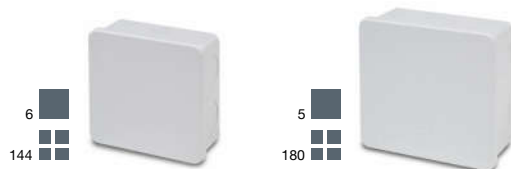

AcquaBOX

Cierre por tornillo 1/4 de vuelta
1/4 turn screw

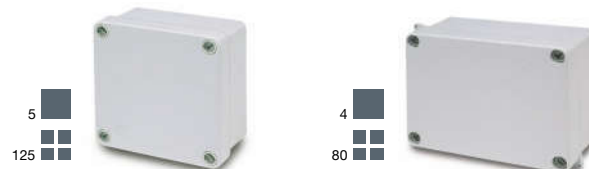

Ref.	3062	3063	3071	3072
Entradas/Entries	-	-	-	-
Dim	80x80x36 mm 3"5/32 x 3"5/32 x 1"27/64	100x100x45 mm 3"15/16 x 3"15/16 x 1"49/64	100x100x55 mm 3"15/16 x 3"15/16 x 2"11/64	100x150x63 mm 3"15/16 x 5"29/32 x 2"31/64

AcquaBOX

Cierre por tornillo 1/4 de vuelta
1/4 turn screw



Ref.	3073	3074	3075
Entradas/Entries	-	-	-
Dim	135x160x83 mm 5"5/16 x 6"19/64 x 3"17/64	175x225x83 mm 6"57/64 x 8"55/64 x 3"17/64	240x310x125 mm 9"29/64 x 12"13/64 x 4"59/64

Accesorios Accessories





IP65

- Marco y base en ABS
- Incluye tapones interiores para IP
- Frame and base in ABS
- Screw taps included for IP



AcquaBOX

Cierre por tornillo 1/4 de vuelta
1/4 turn screw



Ref.	3956	3953	3954	3955
Entradas/Entries	-	-	-	-
Dim	330x330x135 mm 12"63/64 x 12"63/64 x 5"5/16	500x225x135 mm 19"11/16 x 8"55/64 x 5"5/16	500x330x135 mm 19"11/16 x 12"63/64 x 5"5/16	175x380x135 mm 6"57/64 x 14"61/64 x 5"5/16



IP55

- Marco y base en ABS
- Ventana transparente en PC
- Incluye tapones interiores para IP
- Frame and base in ABS
- Windows transparent in PC
- Screw taps included for IP

AcquaBOX

Cierre por tornillo 1/4 de vuelta
1/4 turn screw

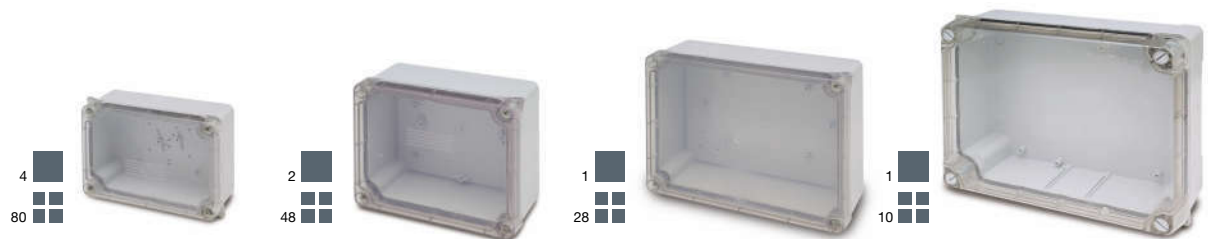

Ref.	3042	3043	3044	3045
Entradas/Entries	-	-	-	-
Dim	110x150x63 mm 4"21/64 x 5"29/32 x 2"31/64	135x160x83 mm 5"5/16 x 6"19/64 x 3"17/64	175x225x85 mm 6"57/64 x 8"55/64 x 3"11/32	240x310x135 mm 9 29/64 x 12"13/64 x 5" 5/16

Accesorios
Accessories

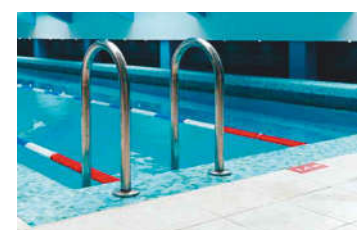

Prensaestopas IP68 / Cable glands IP68



Prensaestopas Cable glands Ref./ Item	Contratuercas Nuts Ref./ Item	Métrica Metric	Unidades bolsa Bag units
3931	3941	M12 - 1/2"	100
3930	3940	M15 - 5/8"	50
3933	3943	M20 - 3/4"	50
3934	3944	M25 - 1"	25
3935	3945	M32 - 1 1/4"	20
3936	3946	M40 - 1 1/2"	10
3937	3947	M50 - 2"	10
3938	3948	M63 - 2 1/2"	10

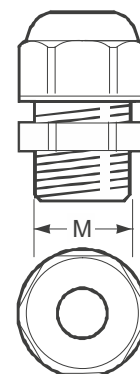

Ref.	Descripción	
204	Regleta de conexión 2,5 mm 24A Blanco	<i>Terminal strip 2,5 mm 24A white</i>
206	Regleta de conexión 6 mm 41A Blanco	<i>Terminal strip 6 mm 41A white</i>
210	Regleta de conexión 10 mm 57A Blanco	<i>Terminal strip 10 mm 57A white</i>
216	Regleta de conexión 16 mm 76A Blanco	<i>Terminal strip 16 mm 76A white</i>
235	Regleta de conexión 35 mm 125A Blanco	<i>Terminal strip 35 mm 125A white</i>



Ref.	Descripción	
204N	Regleta de conexión 2,5 mm 24A Negro	<i>Terminal strip 2,5 mm 24A Black</i>
206N	Regleta de conexión 6 mm 41A Negro	<i>Terminal strip 6 mm 41A Black</i>
210N	Regleta de conexión 10 mm 57A Negro	<i>Terminal strip 10 mm 57A Black</i>
216N	Regleta de conexión 16 mm 76A Negro	<i>Terminal strip 16 mm 76A Black</i>
235N	Regleta de conexión 35 mm 125A Negro	<i>Terminal strip 35 mm 125A Black</i>

La gama de armarios de superficie IP65 Acqua / Aqua+ está formada por ocho modelos de 4 a 72 módulos. Estos armarios están pensados para su aplicación en el sector doméstico y terciario. Están diseñados para soportar ambientes con polvo, humedad, etc. Destacan por su rapidez y facilidad de instalación en cualquier entorno.

The new range of surface enclosures IP65 Acqua/Aqua+ is composed by eight models from 4 to 72 modules. These enclosures are thought for its application in the domestic and tertiary sector. They have been designed to support extrem environments with high levels of humidity and dust. Its easy and fast installation makes them ready to be used in any environment. Its ergonomic design has been studied with the objective of making easy the access to the enclosure once it is installed through a secure opening/closing door system.



UNIVERSAL

Compatible con cualquier marca de breaker europeo de carril DIN
Compatible with any european brand of DIN rail MCB

NOM

IEC

Advanced opening system

Sistema de apertura avanzado



Carril DIN y terminales
incluidos
DIN RAIL & terminals
included

Acqua



Características/ advantages

Alta Resistencia al impacto IK-08 / High impact resistance IK-08
Fabricado en ABS / made in ABS thermoplastic.
De 4 a 72 módulos / from 4 to 72 modules.
Proteccion a la corrosión, salitre y UV / Protected against corrosion, salinity and UV.



3902-TTB	3904-TTB	3908-TTB	3912-TTB	3926-TTB1
4	4	8	12	26
171x100x100 mm 6"47/64x3"15/16x3"15/16	215x145x110 mm 8"15/32 x8"15/32x 4"21/64	215x235x110 mm 8"15/32 x 9"1/4 x 4"21/64	215x310x110 mm 8"15/32 x12"13/64x 4"21/64	410x310x150 mm 16"9/64 x 12"13/64 x 5"29/32
Incluye Included 2x RG-04	Incluye Included SPTC-4	Incluye / Included SPTA-12 + RG-12	Incluye / Included SPTA-12 + RG-12	Incluye / Included SPTA-12 + RG-12

Acqua+

Acqua+



Ref.	3942-TTB1	39054	39072
Mod.	42	54	72
Dim	565x310x150 mm 22,24"x25,4"x5,90"	640x430x160 mm 25,20"x16,9"x6,30"	878x430x160 mm 34,60"x16,9"x6,30"
	Incluye / Included SPTA-12 + RG-12	Incluye / Included 2-SPT-18 / 36	Incluye / Included 3-SPT-18 / 36



- SPTA-12** Soporte de regleta de neutro y tierra para Acqua y Acqua combi + 1 regleta RG-12 (2x16mm2+12x10mm2)
Neutral and earth terminal bar support for Acqua y Acqua Combi + 1 terminal RG-12 (2x16mm2+12x10mm2)
- RG-12** Regleta de neutro y tierra (2x16mm2+12x10mm2)
Neutral and earth terminal bar (2x16mm2+12x10mm2)
- SPTC-4** Soporte de regleta de neutro y tierra para Acqua y Acqua combi + 2 regleta RG-04 (2x16mm2+4x10mm2)
Neutral and earth terminal bar support for Acqua y Acqua Combi + 2 terminal RG-04 (2x16mm2+4x10mm2)
- SPT-18/36** Soporte rail
Rail support



3900
Cerradura
metálica
Metal lock

CAJAS DERIVACIÓN / JUNCTIONS BOXES

Las cajas de empotrar y empalme están fabricadas en termoplástico de alta resistencia estas cajas están diseñadas para su utilización en derivaciones principales y secundarias en el sector residencial, industrial y sector terciario. Todas las cajas están configuradas con entradas de fácil rotura para asegurar una instalación rápida

The embeddable and junction boxes are made of thermoplastic material with high resistance. These boxes are thought for being used in the residential-industrial sector as well as in the tertiary sector. All boxes have knock-outs which can be easily broken speeding up the installation.

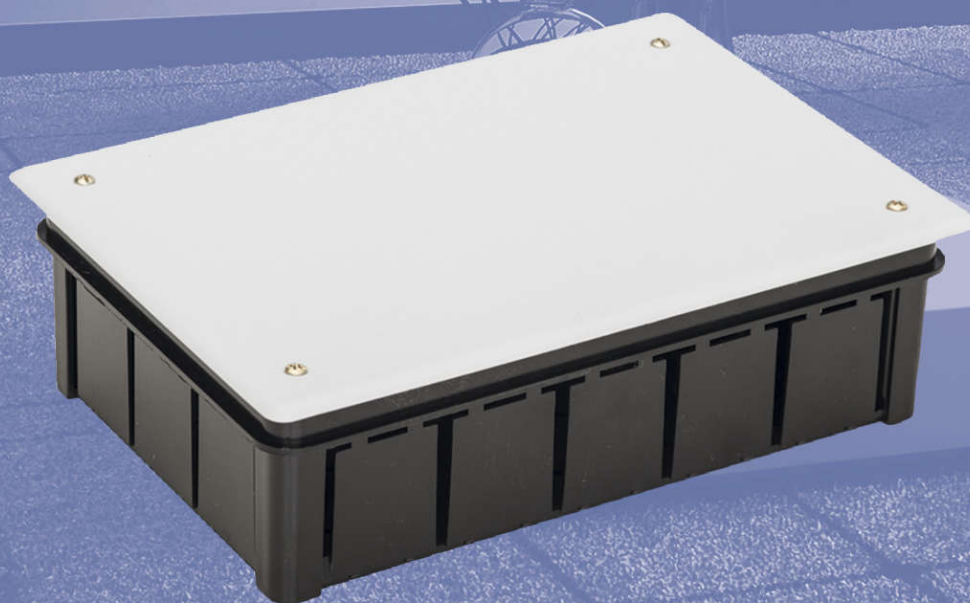
JunctionBOX



- Facilidad de rapidez e instalación.
- Libre de halógenos.
- Alta resistencia al impacto.
- Entradas de fácil rotura.

- Easy and fast installation.
- Halogen free.
- High resistance to impact
- Knock-outs that can be easily broken.



Cierre por garra
Fixing system with grip



Ref.	3102	3201	3202	3203
Entradas/Entries	-	-	-	-
Dim	66x66x41 mm 2"19/32 x 2"19/32 x 1"39/64	100x100x45 mm 3"15/16 x 3"15/16 x 1"49/64	160x100x50 mm 6"19/64 x 3"15/16 x 1"31/32	200x130x60 mm 7"7/8 x 5"1/8 x 2"23/64

Cierre por garra
Fixing system with grip



Cierre por tornillo
Turn screw

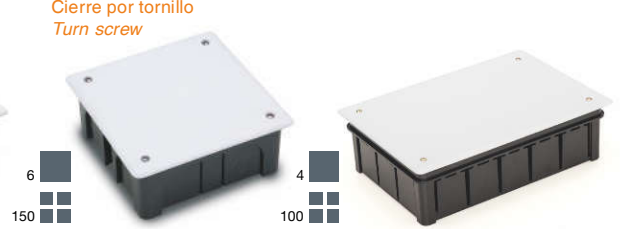

Ref.	3204	3205	3201-T	3202-T
Entradas/Entries	-	-	-	-
Dim	200x200x60 mm 7"7/8 x 7"7/8 x 2"23/64	250x250x65 mm 9"27/32 x 9"27/32 x 2"9/16	100x100x45 mm 3"15/16 x 3"15/16 x 1"49/64	160x100x50mm 6"19/64 x 3"15/16 x 1"31/32

Cierre por tornillo
Turn screw



Ref.	3203-T	3204-T	3205-T
Entradas/Entries	-	-	-
Dim	200x130x60 mm 7"7/8 x 5"1/8 x 2"23/64	200x200x60 mm 7"7/8 x 7"7/8 x 2"23/64	250x250x65 mm 9"27/32 x 9"27/32 x 2"9/16



Entradas de fácil rotura.
Knock-outs that can be easily broken.



Nuevo sistema fijación de la garra para evitar su salida.
New fixing system with grip to guarantee a secure installation.

**ARMARIO DE EMPOTRAR Y SUPERFICIE /
FLUSH AND WALL MOUNTED ENCLOSURES**

La gama de armarios de empotrar y superficie IP40 Nuova está formada por seis modelos de 4 a 36 módulos con opción puerta opaca y puerta transparente. Estos armarios están pensados para su aplicación en el sector residencial y terciario. Su diseño les permite una perfecta integración en todos los entornos decorativos. Destacan por su rapidez y facilidad de instalación. Su diseño ergonómico ha sido estudiado con el objetivo de facilitar el acceso al armario una vez instalado, permitiendo una fácil apertura/cierre de la puerta.

The new range of surface enclosures IP40 Nuova is composed by 6 models that go from 4 to 36 modules with blank and transparent doors. These enclosures are thought for its application in the residential and tertiary sector taking into seriously consideration its design for the integration in decorative environments. Its easy and fast installation is one of the strongest features and the ergonomic design has been studied with the objective of making easy the access to the enclosure once it is installed through a secure opening/closing door system.

UNIVERSAL

Compatible con cualquier
marca de breaker europeo
de carril DIN
*Compatible with any european
brand of DIN rail MCB*

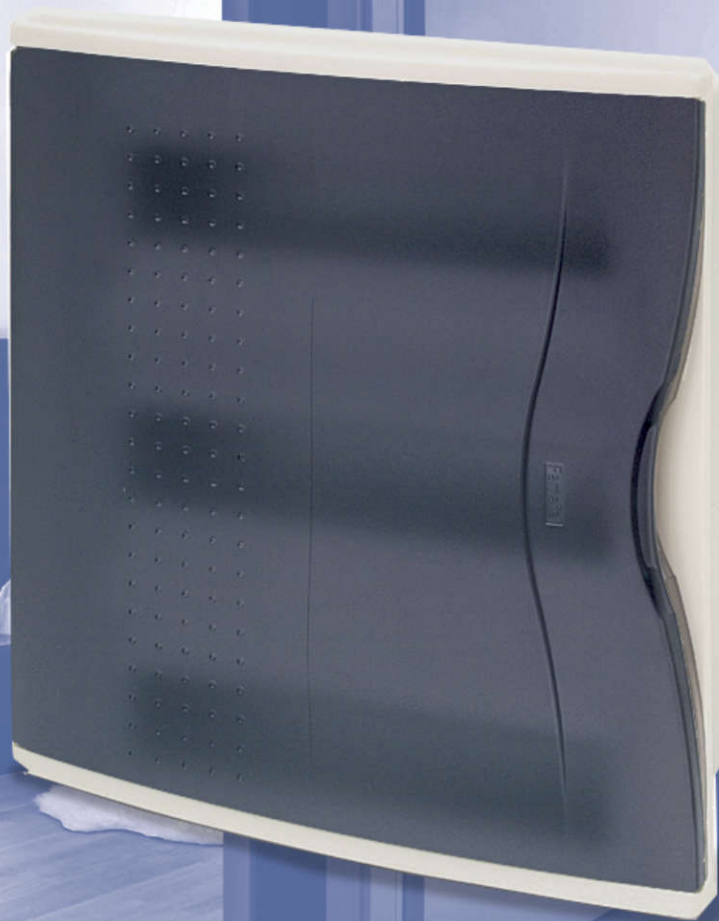

Carril DIN y terminales
incluidos
DIN RAIL & terminals
included

ARMARIO EMBUTIDO IP40 / IP40 FLUSH MOUNTED ENCLOSURES

Nuova

Características

Gama de 4 hasta 36 módulos / *From 4 to 36 modules*
Facilidad y rapidez de instalación / *Easy and fast installation.*
Amplio espacio para el cableado / *Wide space for the cabling.*
Incluidos terminales neutro y tierra / *Included the terminal blocks for neutral and earth connection.*



NOM



Ref.	3504-TB	3508-TB	3512-TB
Entradas/Entries	módulos / <i>modules</i> 4CC	módulos / <i>modules</i> 8/10CC	módulos / <i>modules</i> 12/14CC
Medidas/Dimensions	188x111x55 mm 7"13/32 x 4"3/8 x 2"11/64	188x230x55 mm 7"13/32 x 9"1/16 x 2"11/64	188x276x55 mm 7"13/32 x 10" 55/64 x 2"11/64



Ref.	3518-TB	3524-TB1	3536-TB1
Entradas/Entries	módulos / <i>modules</i> 18CC	módulos / <i>modules</i> 24CC	módulos / <i>modules</i> 36CC
Medidas/Dimensions	188x344x55 mm 7"13/32 x 13"35/64 x 2"11/64	332x286x78 mm 13" 5/64 x 11"17/64 x 3"5/64	440x286x78 mm 17,32"x11"17/64 x 3"5/64

ARMARIO DE SUPERFICIE IP40 / IP40 WALL MOUNTED ENCLOSURES

Nuova

NOM



Ref.	3604-TB	3608-TB	3612-TB
Entradas/Entries	módulos / <i>modules</i> 4CC	módulos / <i>modules</i> 8/10CC	módulos / <i>modules</i> 12/14CC
Medidas/Dimensions	195x120x100 mm 7,68"x4,72"x3,93"	195x238x100 mm 7,68"x9,37"x3,93"	195x284x100 mm 7,68"x11,18"x3,93"



Ref.	3618-TB	3624-TB1	3636-TB1
Entradas/Entries	módulos / <i>modules</i> 18CC	módulos / <i>modules</i> 24CC	módulos / <i>modules</i> 36CC
Medidas/Dimensions	195x350x100 mm 7,68"x13,78"x3,93"	351x305x112 mm 13,81"x12,00"x4,40"	460x305x112 mm 18,11"x12,00"x4,40"

Carril DIN y terminales
incluidos
DIN RAIL & terminals
included

ARMARIO EMBUTIDO IP40 / IP40 FLUSH MOUNTED ENCLOSURES



UNIVERSAL
Compatible con cualquier
marca de breaker europeo
de carril DIN
Compatible with any european
brand of DIN rail MCB



- Portamódulos extraíble
- Amplio espacio para el cableado
- Posibilidad de montar terminales de neutro y tierra*
- Removable DIN rails
- Wide space for the cabling
- Possibility to mount earth/neutral bar*

Norma/Standard: EN 60670-24



3519



3537

Ref.	3519	3537
Entradas/Entries	módulos / modules 18	módulos / modules 36
Medidas/Dimensions	465x300x85 mm 18"5/16 x 11"13/16 x 3"11/32	350x570x87 mm 13"25/32 x 22"7/16 x 3"27/64



3572



3554

Ref.	3572	3554
Entradas/Entries	módulos / modules 72	módulos / modules 54
Medidas/Dimensions	880x465x92 mm 34"41/64 x 18"5/16 x 3"5/8	680x465x95 mm 26"49/64 x 18"6/16 x 3"47/64

Accesorios / Complementary items 10

- Terminal Blocks - 12M / Terminal 12M
- Regleta de neutro y tierra 18M / Neutral and earth terminal 18M

Ref. **SPTD-12**
Ref. **SPTD-18**



Garril DIN y terminales incluidos
DIN RAIL & terminals included

Vita

ARMARIO EMBUTIDO / FLUSH MOUNTED ENCLOSURES



Características

Gama de 60 módulos / Range of 60 modules
Facilidad y rapidez de instalación / Easy and fast installation.
Amplio espacio para el cableado / Wide space for the cabling.
Incluidos los terminales neutro y tierra / Included the terminal blocks for neutral and earth connection.

IP40

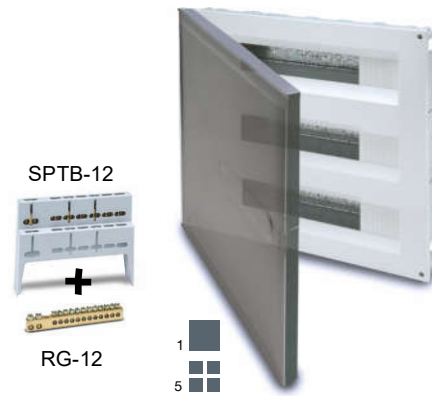
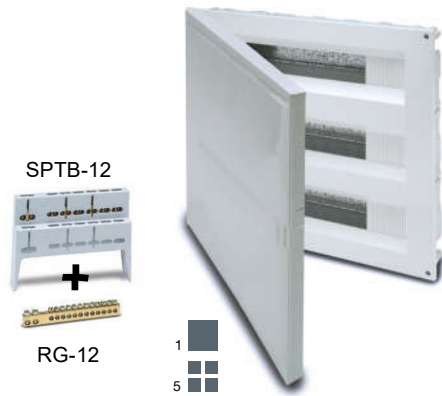

Ref.	3360-PTB	3360-PTTB
Entradas/Entries	módulos / modules 60	módulos / modules 60
Medidas/Dimensions	455x405x70 mm 17"29/32 x 15"15/16 x 2"3/4	455x405x70 mm 17"29/32 x 15"15/16 x 2"3/4

ARMARIO DE SUPERFICIE IP40 / IP40 WALL MOUNTED ENCLOSURES

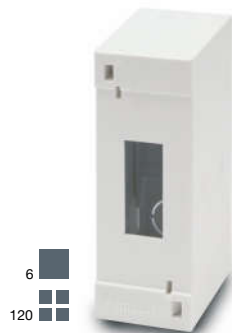

Ref.	3452	3454
Entradas/Entries	módulos / modules 2	módulos / modules 4
Medidas/Dimensions	130x47x63 mm 5"1/8 x 1"27/32 x 2"31/64	130x87x63 mm 5"1/8 x 3"27/64 x 2"31/64



SPTB-12 Soporte de regleta de neutro y tierra para Nuova y Vita + 1 regleta RG-12 (2x16mm²+12x10mm²)
Neutral and earth terminal bar support for Nuova and Vita + 1 terminal RG-12 (2x16mm²+12x10mm²)



RG-12 Regleta de neutro y tierra (2x16mm²+12x10mm²)
Neutral and earth terminal bar (2x16mm²+12x10mm²)

TOMAS Y CLAVIJAS INDUSTRIALES IP44 / IP67; 16A - 125A INDUSTRIAL PLUGS AND SOCKETS IP44 / IP67; 16A - 125A

Ergonomía, Robustez, Seguridad, Rapidez de conexión, Precisión.

La gama de clavijas y tomas industriales SpeedPRO es el resultado de la suma de todas estas propiedades. Diseñadas y fabricadas de acuerdo con las más exigentes normativas de calidad, garantizan el mejor funcionamiento en condiciones extremas de temperatura, impacto y estanqueidad.

Ergonomics, Robustness, Safety, Quick connection, Accuracy.

The range of industrial plugs and sockets SpeedPRO is the result of the addition of all these properties. Designed and manufactured according to the most demanding quality standards, they guarantee the best performance in extreme conditions of temperature, impact and watertightness.



UNIVERSAL

Compatible con otras
marcas Europeas
*Compatible with other
European brands*



NORMATIVAS REGULATIONS

Código de colores Colour coding	20-25V
	40-50V
	100-130V
	200-250V
	380-480V
	500-1000V
>60-500Hz	



CARACTERÍSTICAS TÉCNICAS / TECHNICAL DATA

Norm	IEC/CEI/EN 60309-1 / IEC/CEI/EN 60309-2		
Características técnicas / Technical data			
Tensión de utilización / Operating voltage	100-500V	Temperatura de uso según norma de referencia Temperature of use according to the norm	-25°C / +40°C
Tensión de aislamiento / Insulating voltage	500V	Prueba de hilo incandescente (IEC / EN 60695-2-10) Glow wire test (IEC / EN 60695-2-10)	650°C / 850°C
Frecuencia / Frequency	C.C. -50/500Hz	Material / Material	Poliamida 6 / ABS Polyamide 6 / ABS
Intensidad Nominal / Rated current	16A-32A-63A-125A	Resistencia al impacto (IEC/EN 62262) Impact resistance (IEC / EN 60695-2-10)	IK08
Grado de Protección (IP IEC / EN 60529) Protection degree (IP IEC / EN 60529)	IP44/IP67	Material de contacto / Contact material	Latón / Brass Latón niquelado Nickel-plated Brass
Máxima temperatura de funcionamiento TESTADA Maximum operating temperature TESTED	+70°C		

Resistencia a los agentes químicos y atmosféricos / Chemical resistance

DISOLVENTES / SOLVENTS								ÁCIDOS / ACIDS						BASES				
ACETONA ACETONE		ALCOHOL ALCOHOL			ACEITES OILS			RAYOS UV UV DEGREES	SOLUCIÓN SALINA SALT SOLUTION		CONCENTRADOS CONCENTRATED		DILUIDOS DILUTED		CONCENTRADOS CONCENTRATED		DILUIDOS DILUTED	
PC/ABS	PA6	PC/ABS	PA6	PC/ABS	PA6	PC/ABS	PA6	PC/ABS	PA6	PC/ABS	PA6	PC/ABS	PA6	PC/ABS	PA6	PC/ABS	PA6	PC/ABS
0	+	0	+	+	+	+	+	+	***	***	***	***	***	***	***	***	***	***
"+"		"0"			"****"						Debido a la gran variedad y diferentes concentraciones, consultar con el fabricante Due to the large variety and concentrations request to the producer							
Resistente Resistant		Condicionalmente resistente Conditionally resistant																

Contacto piloto

Sistema de seguridad de conexionado que nos permite la apertura y el cierre de la corriente una vez insertada o extraída la clavija. El contacto piloto es un contacto auxiliar para niveles de corriente de 63A-125A.

Las clavijas se suministran con contacto piloto y las tomas bajo demanda.

Posición horaria Clock Positions

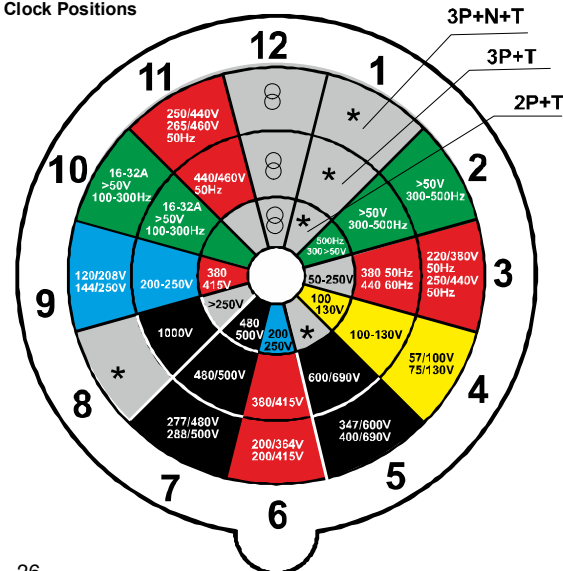

Pilot contact switch

Connection safety system that allows to open and close the current once its inserted or pulled the plug. The pilot contact its an auxiliary contact for levels of current from 63A-125A.

Plugs are provided including pilot contact, but the sockets only under demand.

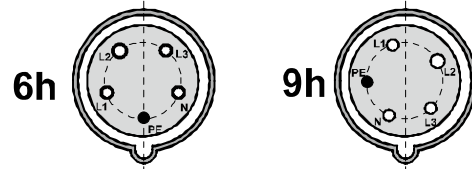

Ejemplo Example	Posición horaria Position of the earthing contact
Utilización normal Normal utilization	h 6
Contenedores fríos Reefer Container Installations	h 3
Instalaciones marítimas, portuarias, navales Shipboard Installations	h 11
Para alm. por transf. aisl. (TST) Supply from an isolating transformer	h 12
Para corriente continua Direct Current	50 a 250 V h 3 más de 250 V h 8
Para alta frecuencia For high frequency	100 a 300 Hz h 10 300 a 500 Hz h 2
Tensiones específicas Special voltage	100 a 300 V h 4 480 a 500 V h 7 600 a 690 V h 5

SpeedPRO Line

Ergonomía, Robustez, Seguridad, Rapidez de conexionado, Precisión.

Diseñadas y fabricadas de acuerdo con las más exigentes normativas de calidad, garantizan el mejor funcionamiento en condiciones extremas de temperatura, impacto y estanqueidad.

Ergonomics, Robustness, Safety, Quick connection, Accuracy.

Designed and manufactured according to the most demanding quality standards, they guarantee the best performance in

Clavija IP44
Plug IP44



Clavija IP67
Plug IP67



Toma IP44
Socket IP44



Toma IP67
Socket IP67



Toma incrustar inclinada IP44
Panel mounting sloping sockets



Toma incrustar inclinada IP67
Panel mounting sloping sockets



Toma de superficie IP44
Surface mounting socket



Toma de superficie IP67
Surface mounting socket



Amp	Tensión Voltage (V)	Polos Poles	H	IP									
16	110-130	2P+T	4H	IP44	13100		23100		23130		23190		
		2P+T	4H	IP67		14100		24100		24130		24190	
		3P+T	4H	IP44	13101		23101		23131		23191		
		3P+T	4H	IP67		14101		24101		24131		24191	
	220-240	2P+T	6H	IP44	13200		23200		23230		23290		
		2P+T	6H	IP67		14200		24200		24230		24290	
		3P+T	9H	IP44	13201		23201		23231		23291		
		3P+T	9H	IP67		14201		24201		24231		24291	
	380-440	3P+T+N	9H	IP44	13202		23202		23232		23295		
		3P+T+N	9H	IP67		14202		24202		24232		24295	
		2P+T	9H	IP44	13304		23304				23364		
		3P+T	6H	IP44	13300		23300		23330		23390		
	500	3P+T	6H	IP67		14300		24300		24330		24390	
		3P+T+N	6H	IP44	13301		23301		23331		23391		
		3P+T+N	6H	IP67		14301		24301		24331		24391	
		3P+T	7H	IP44	13400		23400		23430		23490		
32	110-130	3P+T	7H	IP67		14400		24400		24430		24490	
		3P+T+N	7H	IP44	13401		23401		23431		23491		
		3P+T+N	7H	IP67		14401		24401		24431		24491	
		2P+T	4H	IP44	13102		23102		23132		23192		
	220-240	2P+T	4H	IP67		14102		24102		24132		24192	
		3P+T	4H	IP44	13103		23103		23133		23193		
		3P+T	4H	IP67		14103		24103		24133		24193	
		2P+T	6H	IP44	13203		23203		23233		23292		
		2P+T	6H	IP67		14203		24203		24233		24292	
		3P+T	9H	IP44	13204		23204		23234		23293		
	380-440	3P+T	9H	IP67		14204		24204		24234		24293	
		3P+T+N	9H	IP44	13206		23205		23235		23296		
		3P+T+N	9H	IP67		14210		24210		24240		24296	
		2P+T	9H	IP44	13305		23305				23365		
		3P+T	6H	IP44	13302		23302		23332		23392		
		3P+T	3H	IP67		14308		24308		24339		24398	
500	3P+T	6H	IP67		14302		24302		24332		24392		
	3P+T+N	6H	IP44	13303		23303		23333		23393			
	3P+T+N	6H	IP67		14303		24303		24333		24393		
	3P+T	7H	IP44	13402		23402		23432		23492			
63	110-130	3P+T	7H	IP67		14402		24402		24432		24492	
		3P+T+N	7H	IP44	13403		23403		23433		23493		
	220-240	3P+T+N	7H	IP67		14403		24403		24433		24493	
		2P+T	4H	IP67		14108		24108		24137		24194	
		3P+T	4H	IP67		14109		24109		24138		24195	
		2P+T	6H	IP67		14205		24205		24235		24259	
	380-440	3P+T	9H	IP67		14206		24206		24236		24256	
		3P+T+N	9H	IP67		14209		24209		24238		24257	
	500	3P+T	6H	IP67		14304		24304		24334		24394	
		3P+T+N	6H	IP67		14305		24305		24335		24395	
	125	110-130	3P+T	7H	IP67		14404		24404		24437		24496
			3P+T+N	7H	IP67		14405		24405		24438		24497
		220-240	2P+T	4H	IP67		14110		24110		24139		24196
			3P+T	4H	IP67		14111		24111		24140		24197
		380-440	3P+T	9H	IP67		14208		24208		24239		24258
			3P+T+N	9H	IP67		14211		24211		24277		24297
500		3P+T	6H	IP67		14306		24306		24337		24396	
		3P+T+N	6H	IP67		14307		24307		24338		24397	
500		3P+T	7H	IP67		14406		24406		24436		24498	
		3P+T+N	7H	IP67		14407		24407		24440		24499	

Ergonomía, Robustez, Seguridad, Rapidez de conexión, Precisión.

Diseñadas y fabricadas de acuerdo con las más exigentes normativas de calidad, garantizan el mejor funcionamiento en condiciones extremas de temperatura, impacto y estanqueidad.

Ergonomics, Robustness, Safety, Quick connection, Accuracy.

Designed and manufactured according to the most demanding quality standards, they guarantee the best performance in



Unidades por estuche / Units per sleeve

3P = 2P + T
4P = 3P + T
5P = 3P + T + N

Clavija IP44
Plug IP44



Toma IP44
Socket IP44



Toma incrustar inclinada IP44
Panel mounting sloping sockets



Toma de superficie IP44
Surface mounting socket



Amp	Poles	Clavija IP44	Toma IP44	Toma incrustar inclinada IP44	Toma de superficie IP44
16	3	10	10	10	3
	4	10	10	10	3
	5	8	5	8	3
32	3	5	4	5	2
	4	5	4	5	2
	5	4	3	5	2

Unidades por estuche / Units per sleeve

3P = 2P + T
4P = 3P + T
5P = 3P + T + N

Clavija IP67
Plug IP67



Toma IP67
Socket IP67



Toma incrustar inclinada IP67
Panel mounting sloping sockets



Toma de superficie IP67
Surface mounting socket



Amp	Poles	Clavija IP67	Toma IP67	Toma incrustar inclinada IP67	Toma de superficie IP67
16	3	10	10	10	3
	4	8	6	8	3
	5	6	4	8	3
32	3	4	3	5	2
	4	4	3	5	2
	5	3	3	5	2
63	3	10	10	10	3
	4	10	10	10	3
	5	10	10	10	3
125	3	2	2	2	1
	4	2	2	2	1
	5	2	2	2	1

SpeedPRO IP67

base interbloqueante superficie vertical / switched interlocked wall mounted socket vertical

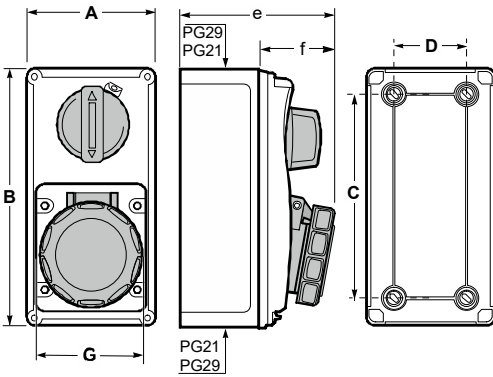

	16A	32A	32A
Poles	3	4	5
A	90mm / 3,54"	90mm / 3,54"	90mm / 3,54"
B	180mm / 7,08"	180mm / 7,08"	180mm / 7,08"
C	140mm / 5,51"	140mm / 5,51"	140mm / 5,51"
D	79mm / 3,11"	79mm / 3,11"	70mm / 2,75"
e	105mm / 4,13"	165mm / 6,50"	105mm / 4,13"
f	50mm / 1,97"	60mm / 1,97"	60mm / 1,97"
G	62mm / 2,44"	82mm / 3,23"	87mm / 3,42"
Connection type	Conexión por tornillo / Screw terminals		
Wire flexible (mm ²)	1 - 2,5	2,5 - 6	2,5 - 6
Weight (g)	488	562	582



- Terminales con tornillo
- Material: PA6/ABS
- Contactos: Niquelados
- Bloqueo conexionado mecánico

IP67 Hermético

- With screw terminals
- Housing material: PA6/ABS
- Contacts: Nickel-plated contacts
- Mechanical Interlocked

IP67 Watertight

UNIVERSAL
Compatible con otras
marcas Europeas
Compatible with another
European brands

Corriente nominal Nominal current	Tensión Voltage	Nº Polos Poles	Pack unit	Ref./ Item
16A	220-240V	2P+T	1	26000
32A	380-440 V	3P+T	1	26004
32A	380-440 V	3P+T+N	1	26005



- Bloqueo conexionado mecánico:
 - Después del conexionado de la clavija y puesto el switch en ON, la clavija queda bloqueada
 - Después de puesto el switch en OFF y extraída la clavija, el mando queda bloqueado.
- Mechanical interlocked:
 - After plugging and switching-on the plug is locked.
 - After switching-off and unplugging switch is locked.

En posición ON o OFF del mando es posible de poner candado por seguridad
At switch ON or OFF position, its possible to be lockable by padlock



INTERRUPTORES DE CORTE / SAFETY SWITCHES

Interruptores / Switches

1

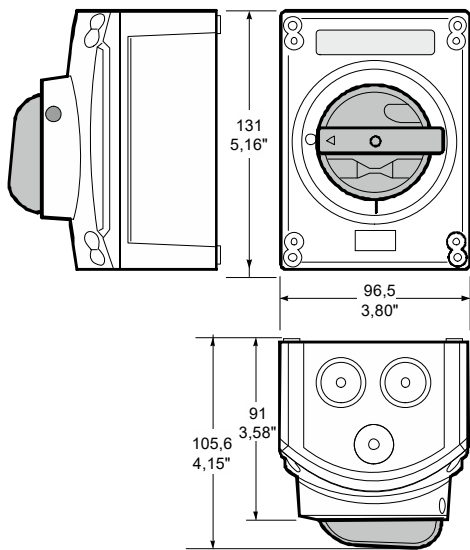

- Interruptor de corte diseñado para aplicaciones industriales y de consumo.
- Estructura dividida en 3 partes, fondo, cubierta (fabricado con materiales con alta resistencia mecánica a los golpes) y el interruptor interno.
- Disconnecting switch designed for industrial and domestic applications.
- Structure divided into 3 parts, bottom, cover (manufactured with high mechanical resistance materials) and the internal switch.



Corriente nominal Nominal current	Nº Polos Poles	Notas Notes	Ref./ Item
40 A	3+E	Solid Neutral	25508

ADAPTADOR MULTIPLE 3 TOMAS BAJA TENSIÓN IP67

MULTIPLE ADAPTOR LOW VOLTAGE 50/60 Hz IP67

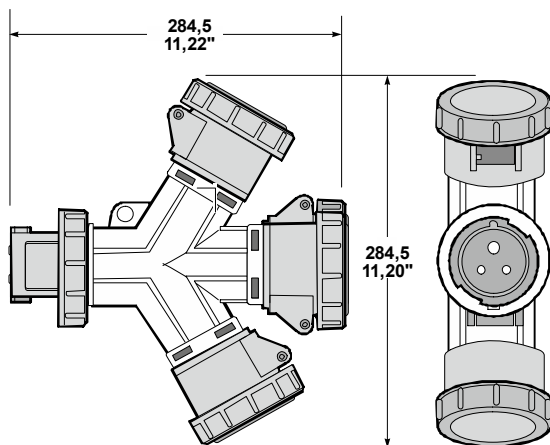

UNIVERSAL
Compatible con otras
marcas Europeas
Compatible with another
European brands



Corriente nominal Nominal current	Tensión Voltage	Nº Polos Poles	Pack unit	Ref./ Item
16 A	220-240V	2P+T	2	16002
32 A	380-440 V	3P+T	4	16009
32 A	380-440 V	3P+T+N	4	16005

UNIVERSAL

Compatible con cualquier
marca de breaker europeo
de carril DIN
*Compatible with any european
brand of DIN rail MCB*

UNIVERSAL

Compatible con otras
marcas Europeas
*Compatible with other
European brands*

NOM



- Gama modulable según sus necesidades de instalación
- Sistema de sujeción de tomas de corriente universal (admite el 90% de las tomas del mercado)
- Facilidad y rapidez de montaje
- Diseñadas para su utilización en entornos industriales asegurando una alta resistencia a los agentes externos

- Modular range according to your needs
- Universal clamping system for flange sockets (accepts the 90% of the flange sockets available on the market)
- Easy and fast of assembly
- Designed for its use in industrial environments, ensuring a high resistance to external agents

CAJAS INDUSTRIALES IP65
INDUSTRIAL ENCLOSURES IP65

Nuevo concepto de cajas industriales modulares IP65, enlazables en sentido vertical y horizontal mediante racords de unión. La gama está compuesta por más de 12 modelos enlazables entre sí: cajas estancas, cajas universales para tomas industriales, cajas para los elementos de protección (diferenciales, magnetotérmicos, bobinas de emisión, etc).

A new concept of modular 65 industrial enclosures, linkable vertically and horizontally through a simple joining accessory. The range consists of over 12 models linkable together, sealed boxes for switchgears (circuit breakers, shunt, RCCB's, etc).



12 modelos combinables según necesidades
12 models to combine accordingly to your needs

Admite cualquier toma del mercado sin necesidad de troquelar
Ready to adapt any industrial socket available on the market without drilling the box

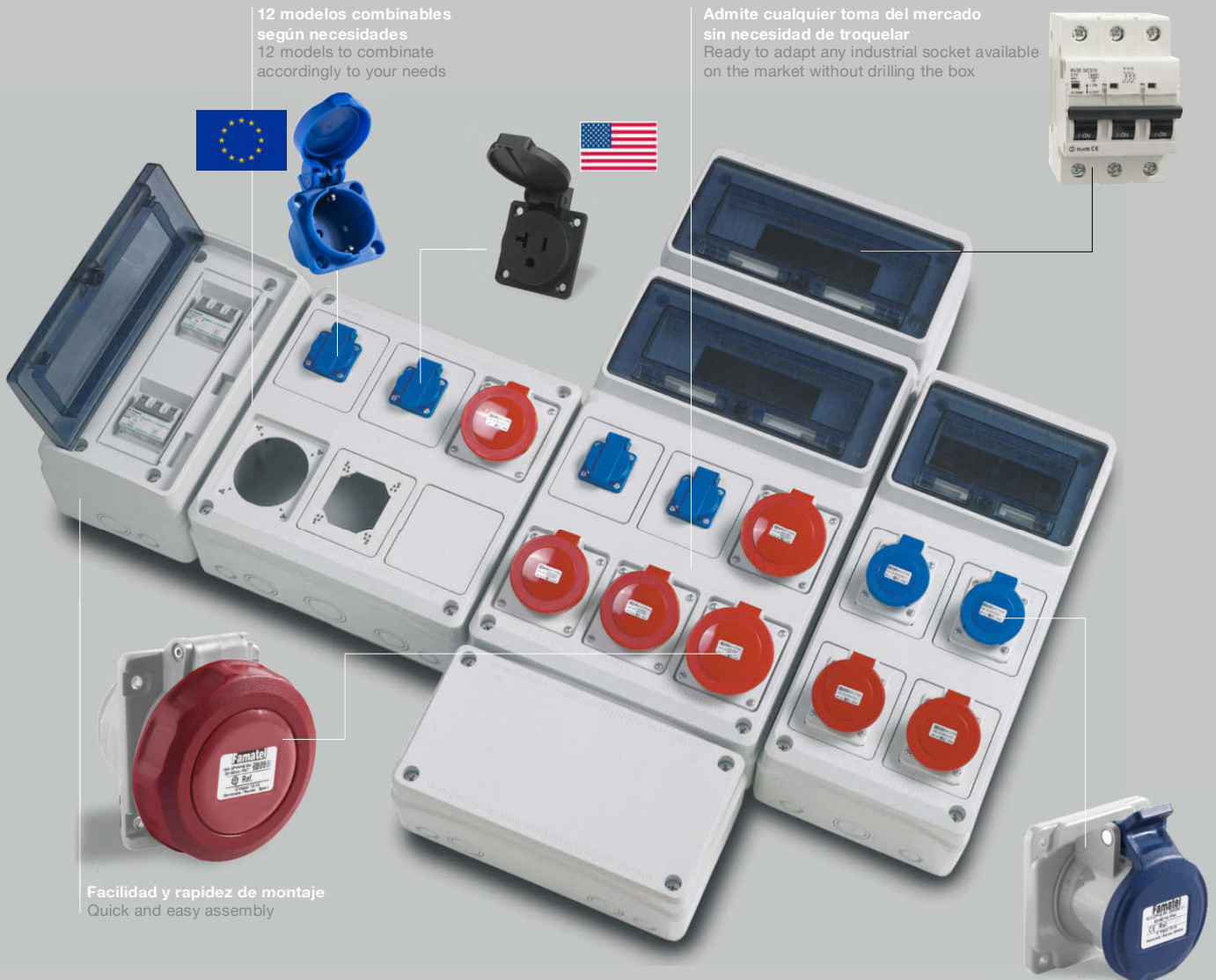

Facilidad y rapidez de montaje
Quick and easy assembly



Racord de unión para cajas industriales AcquaCOMBI
Link for AcquaCOMBI boxes

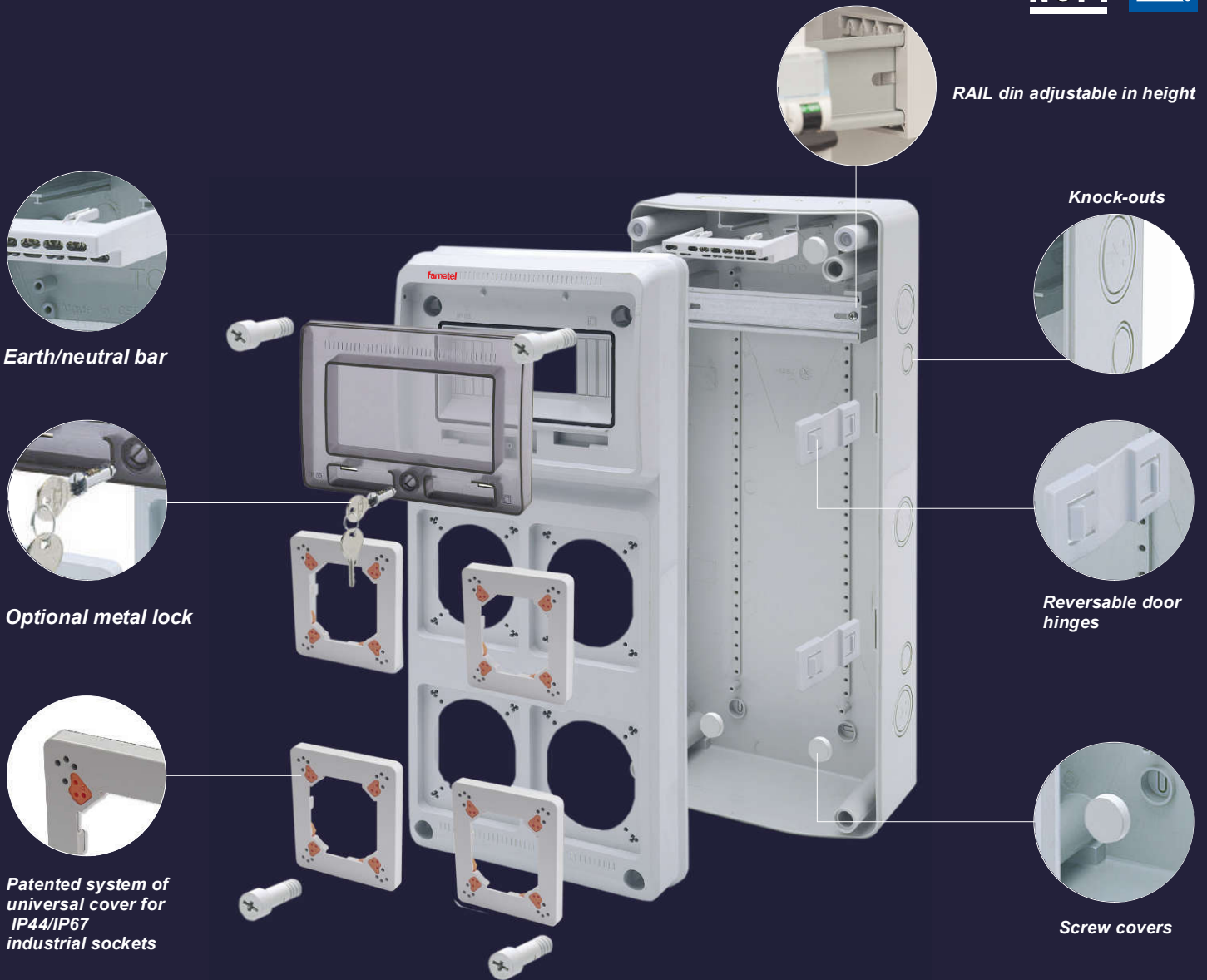

AcquaCOMBI
DoubleTWIST



This new patented system offers you the possibility of installing up to more than 95% of industrial sockets on the market on a single plate.



Carril DIN y terminales incluidos
DIN RAIL & terminals included

AcquaCOMBI



- Marco y base en ABS
- Ventana transparente en PC
- Incluye tapones interiores para IP



- Frame and base in ABS
- Windows transparent in PC
- Screw taps included for IP



Ref.	3928	3960-TB	3961-TB	3975-TB	3962-TB
Mod.	6	6	8	16	16
Dim	305x125x107 mm 12"1/64 x 4"59/64 x 4"7/32	490x125x105 mm 19"19/64 x 4"59/64 x 4"9/64	500x230x155 mm 19"11/16 x 9"1/16 x 6"7/64	217x307x105 mm 8"35/64 x 12"3/32 x 4"9/64	500x300x155 mm 19"11/16 x 11"13/16 x 6"7/64
		Incluye / Included SPTC-4	Incluye / Included SPTA-12 + RG-12	Incluye / Included SPTA-12 + RG-12	Incluye / Included SPTA-12 + RG-12



Ref.	3950-TB	3951-TB	3974-TB
Mod.	6	8	16
Dim	490x125x105 mm 19"19/64 x 4"59/64 x 4"9/64	500x230x155 mm 19"11/16 x 9"1/16 x 6"7/64	217x307x105 mm 8"35/64 x 12"3/32 x 4"9/64
		Incluye / Included SPTA-12 + RG-12	Incluye / Included SPTA-12 + RG-12

Accesorios
Accessories

AcquaCOMBI



3901
Tapa ciega
Blind cover



3905
Placa para toma de corriente
de cuadro 50x50
Cover for panel sockets outlets 50x50



3909
Placa vacia para
63A
Cover for 63A



3924
Contacto NC
NC contact

3919
Contacto NO
NO contact



3903
Racor de unión
Link accessory

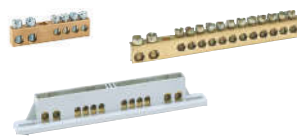

RG-04
Regleta neutro y tierra
Terminal bar

RG-12
Regleta neutro y tierra
Terminal bar

SPTC-4
Regleta neutro y tierra
Terminal bar



3917
Asa
Handle

13958
Toma de cuadro IP54
Panel socket IP54
15/20 A - 125V
50x50



3900
Cerradura
metálica
Metal lock



13950
Toma de cuadro IP54
Panel socket IP54
16 A - 230V
50x50



13955
Caja para tomas cuadro 50x50
Box for panel sockets 50x50



150039980
Soporte metálico
Metal support

*Consultar mas modelos
See more models

CONFIGURACIÓN DE CUADROS DE OBRA / CONFIGURATION OF INDUSTRIAL ENCLOSURES

El primer software para la configuración de cuadros de obra según sus necesidades.
Solicite cualquier combinación, nuestro departamento técnico está a su disposición.

The first software for the configuration of industrial enclosures in accordance with your request.
Request any combination, our technical department is at your disposal.

1°

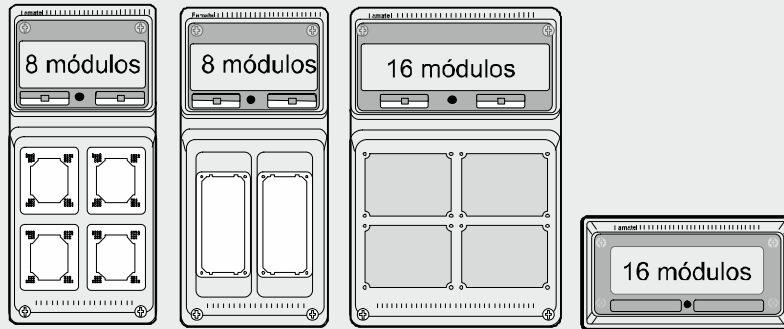

Elija el tipo de caja
Select the box



2°

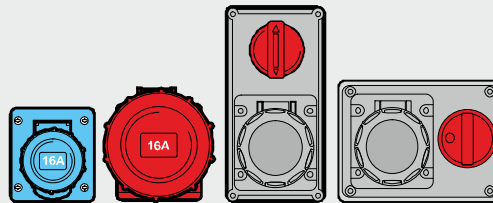

Seleccione las tomas
Select the sockets



3°



Seleccione las protecciones
Select the protection devices

CONFIGURACIÓN DE CUADROS DE OBRA / CONFIGURATION OF INDUSTRIAL ENCLOSURES

This screenshot shows the initial configuration stage of the software. A 3D model of an industrial enclosure rack is displayed in the center, with various modules and components installed. Below the rack, a table lists the components being used:

Código	Descripción	Cantidad
3803		1
3804		1
3805		1

The interface also features a sidebar with 'CAJAS' (enclosures) and a right-hand panel with 'Temperatura Ambiente' controls and a reference number 'ref. 25700042'.



This screenshot displays the wiring diagram stage. A central power source is connected to a horizontal bus, which then branches out to several terminal blocks. Each terminal block is connected to a specific load or device. A warning message at the bottom reads: '¡ATENCIÓN! No se debe seleccionar esta opción si se requiere'.



This screenshot shows the final configuration summary for the 'WFFTA APARADO INDUSTRIAL'. The interface includes a table with the following columns: 'Código', 'Descripción', 'Cantidad', 'Unidad', 'Observaciones', and 'Observaciones 2'. The table lists various components and their quantities:

Código	Descripción	Cantidad	Unidad	Observaciones	Observaciones 2
3803		1	Unidad		
3804		1	Unidad		
3805		1	Unidad		

The interface also includes a sidebar with 'CAJAS' and a right-hand panel with 'Temperatura Ambiente' controls and a reference number 'ref. 24222'.



TIRAS STRIPS	REFERENCIA CODE	Nº TIRAS POR CAJA Nº STRIPS PER BOX
16x40 mm 2 m	71567	32
20x50 mm 2 m	71577	20
60x90 mm 2 m	71596	4

Adhesivas | Adhesives

TIRAS STRIPS	REFERENCIA CODE	Nº TIRAS POR CAJA Nº STRIPS PER BOX
7x12 mm Adhesivo 2 m	71518-A	60
10x20 mm Adhesivo 2 m	71529-A	24
16x25 mm Adhesivo 2 m	71560-A	12

Efecto madera | Adhesivas Wood effect | Adhesives

TIRAS STRIPS	REFERENCIA CODE	Nº TIRAS POR CAJA Nº STRIPS PER BOX
7x12mm 2m	71618-A	60
10x16mm 2m	71628-A	30
10x20mm 2m	71629-A	24

Accesorios / Accessories

ACCESORIO
UNIVERSAL
UNIVERSAL
ACCESSORY



Universal accessories x 5

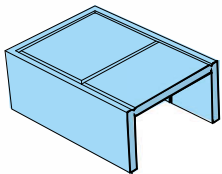

Un solo accesorio para 6 posibilidades
One single accessory for 6 possibilities

	REFERENCIA CODE	CAJA BOX
7x12 mm Bolsa 5 unidades Plastic bags 5 units	71717-B	10 Bolsas 10 Plastic bags
10x20 mm Bolsa 5 unidades Plastic bags 5 units	71729-B	10 Bolsas 10 Plastic bags
16x25 mm Bolsa 5 unidades Plastic bags 5 units	71760-B	10 Bolsas 10 Plastic bags
16x40 mm Bolsa 5 unidades Plastic bags 5 units	71767-B	5 Bolsas 5 Plastic bags
20x50 mm Bolsa 5 unidades Plastic bags 5 units	71777-B	5 Bolsas 5 Plastic bags
7x12 mm Bolsa 5 unidades Plastic bags 5 units	71817-B	10 Bolsas 10 Plastic bags
10x16 mm Bolsa 5 unidades Plastic bags 5 units	71827-B	10 Bolsas 10 Plastic bags
10x20 mm Bolsa 5 unidades Plastic bags 5 units	71829-B	10 Bolsas 10 Plastic bags

Top cover

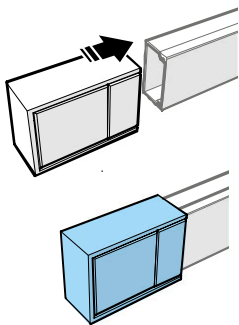

Interior angle

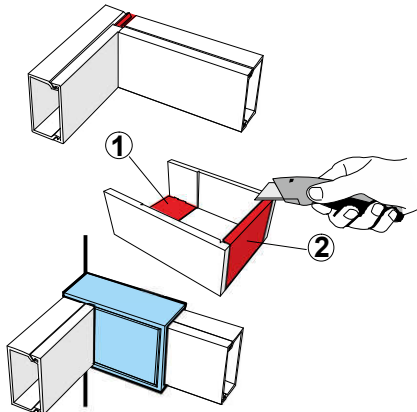

Outer corner

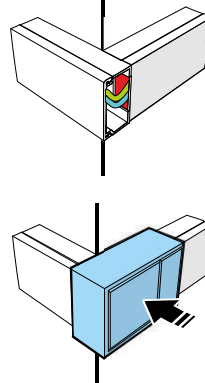

"T" angle

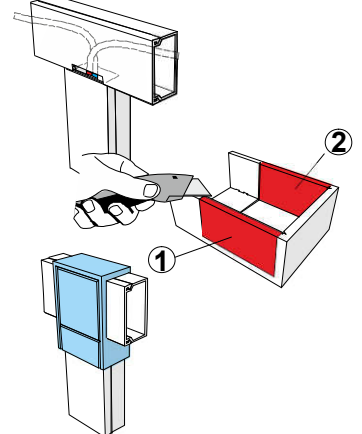

"L" angle

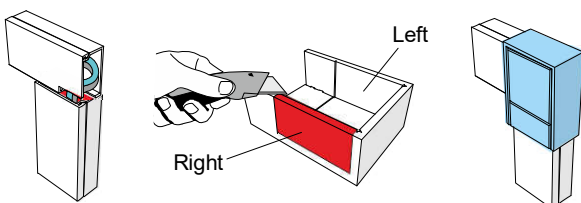

Coupling

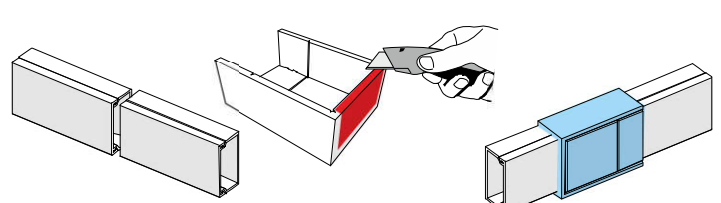

EASY LIFE

TECH

Clever Products for Clever Homes

by: **famatel**
USA



USB Chargers & Extension Cords with Built in Reel

Cargadores USB y extensiones
enrollacables



6 ft 6 in Dual USB Charging Station with built in reel.
Extensiones Enrollables

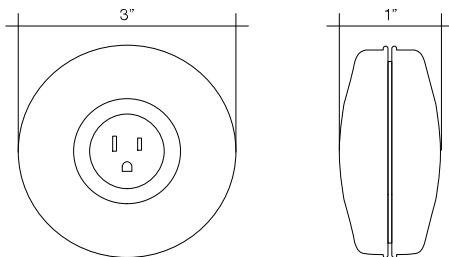

Dual USB charger with roll-able Extension Cord.
Cargadores USB

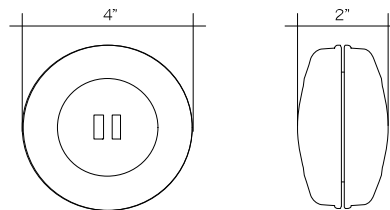

6.56 ft Cord
Cable de 6.56 ft



Compact Design
Diseño compacto



Easy to Roll
Fácil de enrollar

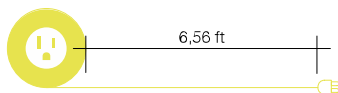

Extend your power connection up to 6.56 ft without the need of having a power outlet near by.

Avoid tangled cables with the clever silicone sleeves by pulling just the right amount of cord.

Practical for home and office use. Great for travel and on the go life style.

Extensión eléctrica que te permite alargar tu distancia de conexión hasta 6.56 ft, sin necesidad de tener un enchufe cerca.

Práctico para uso en el hogar y oficina.

Diseñado para ocultar el cable que no se use y mantener el orden.
Evita que los cables se enreden.



Reference

Color

Description

2958

Green
Verde

Dual USB Outlet charger, Maximum 2.1 A, 5V DC, 6.56 ft Cord. With built in reel for cord concealment.

2 Tomas USB, 2.1 A Máximo, 5V DC, Cable de 6.56 ft. Enrollable para mantener orden con el cable.



2995

Green
Verde

1 Outlet, 13 A, 125 V, 6.56 ft Cord. With built in reel for cord concealment.

1 Toma, 13 A, 125 V, Cable de 6.56 ft. Enrollable para mantener orden con el cable.



2995-B

Blue
Azul

1 Outlet, 13 A, 125 V, 6.56 ft Cord. With built in reel for cord concealment.

1 Toma, 13 A, 125 V, Cable de 6.56 ft. Enrollable para mantener orden con el cable.



2995-O

Orange
Naranja

1 Outlet, 13 A, 125 V, 6.56 ft Cord. With built in reel for cord concealment.

1 Toma, 13 A, 125 V, Cable de 6.56 ft. Enrollable para mantener orden con el cable.

EASY LIFE
TECH by: famatel
USA



Outdoor Extension Cords IP67 / NEMA 4X

Alargadores para exteriores



Extension Length 25/50 ft
Longitud 25/50 ft



Watertight Nema 4X
Protección Nema 4X



Easy to use
Fácil de usar

Outdoor extension cords with built in safety connection seal IP67/NEMA4X.

Available with Extension Length of 25 & 50 ft.

Great for home and professional outdoor use. The most advanced and protected extension cord in the market.

Extensiones para exteriores con protección para la conexión IP67/ Nema 4X.

Disponible en longitud de extensión a 25 & 50 Pies.

Conexión de seguridad a prueba de agua nivel IP67 / Nema 4X. Ideal para uso doméstico y profesional para exterior. La extensión más avanzada y protegida del mercado.

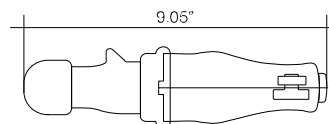

Reference	Color	Description
2996	Orange Naranja	15 Amp outlet, 125 V, 1875 W Maximum, Insulated for 300 V, 25 ft Cord, built in safety connection seal watertight rating IP67/NEMA 4X. 14 Gauge. Toma de 15 Amp, 125 V, 1875 W Máximo, Aislamiento para 300V, Cable de 25 ft, conexión de seguridad a prueba de agua nivel IP67 / Nema 4X
2997	Orange Naranja	15 Amp outlet, 125 V, 1875 W Maximum, Insulated for 300 V, 50 ft Cord, built in safety connection seal watertight rating IP67/NEMA 4X. 14 Gauge. Toma de 15 Amp, 125 V, 1875 W Máximo, Aislamiento para 300V, Cable de 25 ft, conexión de seguridad a prueba de agua nivel IP67 / Nema 4X.
2998-O	Orange Naranja	15 Amp outlet, 125 V, 1875 W Maximum, Insulated for 300 V, built in safety connection seal watertight rating IP67/NEMA 4X. Toma de 15 Amp, 125 V, 1875 W Máximo, Aislamiento para 300 V, conexión de seguridad a prueba de agua nivel IP67 / Nema 4X.
2998-G	Green Verde	15 Amp outlet, 125 V, 1875 W Maximum, Insulated for 300 V, built in safety connection seal watertight rating IP67/NEMA 4X. Toma de 15 Amp, 125 V, 1875 W Máximo, Aislamiento para 300 V, conexión de seguridad a prueba de agua nivel IP67 / Nema 4X.



Power Strips

Regletas



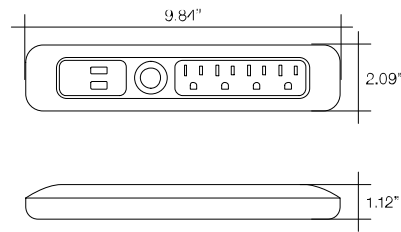
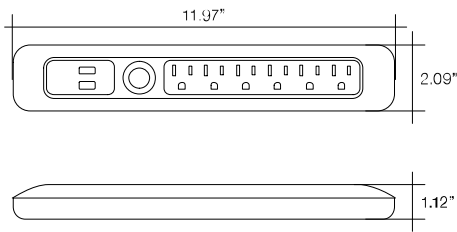

Outputs
Tomas



USB Outputs
Tomas USB
Max. 3,4 A, 5V DC



Flat Plug
Enchufe Plano



Surge Protection
Protección Contra
Sobretensiones
1200 J



Extra-long Cord
Cable extra-largo



On/Off Switch
Botón ON/OFF

Our Power Strips are equipped with surge protection technology that ensures connection safety. It also offer convenient USB ports to quickly charge your portable devices.

Designed for home and office use. Reach any outlet, thanks to its right angle flat plug.

Nuestra gama de regletas emplea tecnología de protección contra sobretensiones que garantizan un uso seguro para los dispositivos. Además ofrece multiconectividad con dispositivos USB.

Diseñado para uso en el hogar y la oficina. Llega a cualquier enchufe, gracias a su enchufe plano.



Reference	Color	Description
0-2517	White Blanco	6 Outlets - 6 ft. cord-Flat Plug - Surge Protection - 1200 J 6 Tomas - 6 ft. de cable-clavija plana - Protección Contra Sobrecarga -1200 J



0-2517-N	Black Negro	6 Outlets - 6 ft. cord-Flat Plug - Surge Protection - 1200 J 6 Tomas - 6 ft. de cable-clavija plana - Protección Contra Sobrecarga -1200 J
----------	----------------	---



0-2518	White Blanco	6 Outlets - 2 USB - 6 ft. cord-Flat Plug - Surge Protection - 1200 J 6 Tomas - 2 USB - 6 ft. de cable-clavija plana - Protección Contra Sobrecargas -1200 J
--------	-----------------	--



0-2518-N	Black Negro	6 Outlets - 2 USB - 6 ft. cord-Flat Plug - Surge Protection - 1200 J 6 Tomas - 2 USB - 6 ft. de cable-clavija plana - Protección Contra Sobrecargas -1200 J
----------	----------------	--



0-2627	White Blanco	4 Outlets - 6 ft. cord-Flat Plug - Surge Protection - 1200 J 4 Tomas - 6 ft. de cable-clavija plana - Protección Contra Sobrecarga - 1200 J
--------	-----------------	--



0-2627-N	Black Negro	4 Outlets - 6 ft. cord-Flat Plug - Surge Protection - 1200 J 4 Tomas - 6 ft. de cable-clavija plana - Protección Contra Sobrecarga - 1200 J
----------	----------------	--



0-2628	White Blanco	4 Outlets - 2 USB - 6 ft. cord-Flat Plug - Surge Protection -1200 J 4 Tomas - 2 USB - 6 ft. de cable-clavija plana - Protección Contra Sobrecarga - 1200 J
--------	-----------------	---



0-2628-N	Black Negro	4 Outlets - 2 USB - 6 ft. cord-Flat Plug - Surge Protection -1200 J 4 Tomas - 2 USB - 6 ft. de cable-clavija plana - Protección Contra Sobrecarga - 1200 J
----------	----------------	---

Wall Power Strips

Regletas



Outputs
Tomas



USB Outputs
Tomas USB
Max. 3,4 A, 5V DC



Surge Protection
Protección Contra
Sobretensiones
1200 J



On/Off Switch
Botón ON/OFF

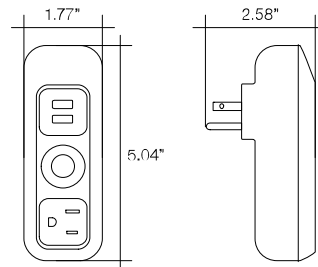

Reference	Color	Description
0-1301	White Blanco	2 Outlets - 2 USB 2 Tomas - 2 USB
0-1302	White Blanco	1 Outlet - 2 USB - Surge Protection - 1200 J 1 Toma - 2 USB - Protección Contra Sobrecarga -1200 J

Base Power Strips

Bases de conexión



Outputs
Tomas



USB Outputs
Tomas USB



Flat Plug
Enchufe Plano



Surge Protection
Protección Contra
Sobretensiones
1200 J



Extra-long Cord
Cable extra-largo



On/Off Switch
Botón ON/OFF

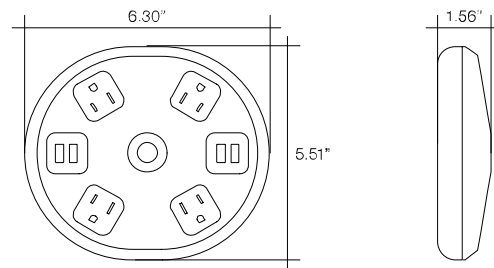

Reference

Color

Description

0-2514

White
Blanco

4 Outlets - 4 USB - 6 ft. cord-flat plug -
Surge Protection - 1200 J
4 Tomas - 4 USB - 6 ft. de cable-clavija plana -
Protección Contra Sobrecarga -1200 J

0-2514-N

Black
Negro

4 Outlets - 4 USB - 6 ft. cord-flat plug -
Surge Protection - 1200 J
4 Tomas - 4 USB - 6 ft. de cable-clavija plana -
Protección Contra Sobrecarga -1200 J

Cable Management Kits

Canal para Manejo de Cables

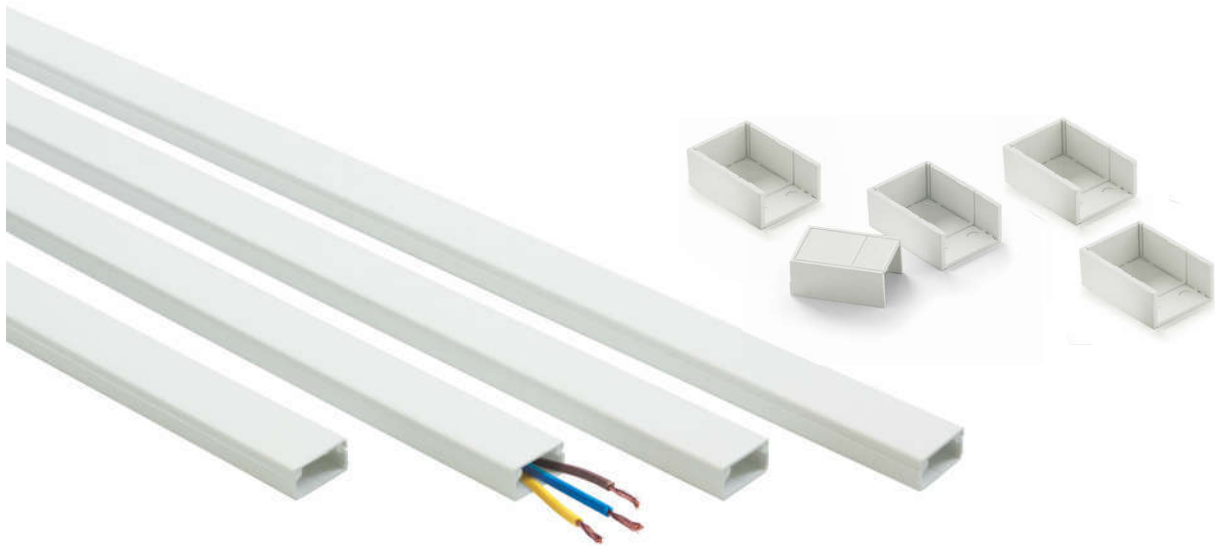

Ideal for the concealment of cords for: computers, tv's, audio systems and other cables around home or office. EasyLife design to blend with any decor.

Ideal para la ocultación de los cables de: computadoras, televisores, sistemas de audio y otros cables alrededor de la casa u oficina. Diseño EasyLife para mezclar con cualquier decoración.

Simple to install on baseboards and walls.

Fácil de instalar en zócalos y paredes.

Includes 5 universal joints. Our EasyLife Tech joint is a universal accessory that allows multiple types of joints saving you multiple trips to the hardware store

Incluye 5 Accesorios de unión. Nuestro sistema de unión EasyLife Tech es un accesorio universal que permite múltiples tipos de articulaciones / uniones ahorrando repetidos viajes a la tienda de ferretería

Universal accessory joint / One accessory does all
Accesorio universal para juntas / Un accesorio lo hace todo

Top Cover Tapa Final

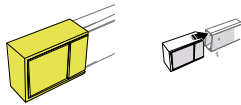

Interior Angle Ángulo interior

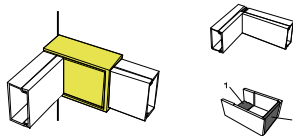

Outer Corner Ángulo exterior

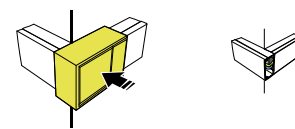

"L" Angle Ángulo en "L"

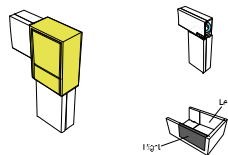

"T" Angle Ángulo en "T"

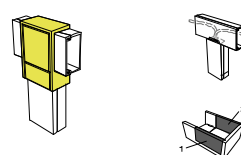

Coupling Junta

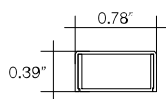
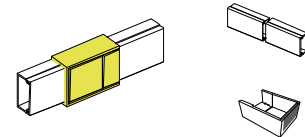

Reference	Color	Length	Description
71529-A-1.22	White Blanco	48 In (x4)	16 ft of cable raceway in one inclusive Kit; 4 self-adhesive cable channels (48 inc/each), 5 universal joints, Paintable.
71629-A-1.22	Brown Marrón	48 In (x4)	16 ft. de canaleta para cable en un solo KIT con todo Incluido: 4 Tiras de Canal (48 pulgadas de largo / cada una), 5 Juntas Universales, Auto-Adhesivo, la superficie se puede pintar

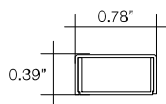

71529-A-0.76	White Blanco	30 In (x4)	10 ft of cable raceway in one inclusive Kit; 4 self-adhesive cable channels (30 inc/each), 5 universal joints, Paintable.
71629-A-0.76	Brown Marrón	30 In (x4)	10 ft. de canaleta para cable en un solo KIT con todo Incluido: 4 Tiras de Canal (30 pulgadas de largo / cada una), 5 Juntas Universales, Auto-Adhesivo, la superficie se puede pintar.

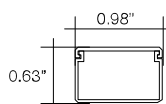

71560-A-0.76	White Blanco	30 In (x4)	10 ft of cable raceway in one inclusive Kit; 4 self-adhesive cable channels (30 inc/each), 5 universal joints, Paintable
71660-A-0.76	Brown Marrón	30 In (x4)	10 ft. de canaleta para cable en un solo KIT con todo Incluido: 4 Tiras de Canal (30 pulgadas de largo / cada una), 5 Juntas Universales, Auto-Adhesivo, la superficie se puede pintar

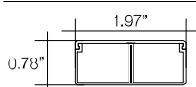

71577-0.76	White Blanco	30 In (x4)	
------------	-----------------	------------	--

Nema Plugs & Connectors

Clavijas y conectores Nema

Built with PP & PC with high impact resistance.

Ideal for plug replacement on tools, appliances and extension cords.

Available in different colors.

Easy to open & easy to connect.

Professional plugs and sockets with a handle to hang up anywhere.

Rubber exterior to resist impact and professional uses.

Intertek certified.

Construídas en PP y PC con alta resistencia al impacto.

Ideal para recambios de clavijas en herramientas, accesorios y cables de extensión.

Disponible en diferentes colores.

Fácil apertura y fácil de conectar.

Clavijas y conectores profesionales con un asa para colgar en cualquier sitio.

Goma exterior para resistir el impacto y para uso profesional.

Certificado Intertek.



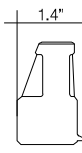
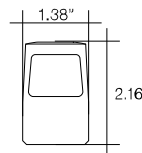
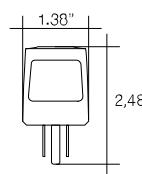
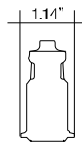
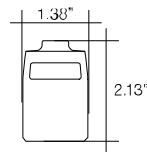
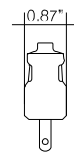
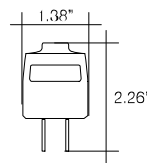
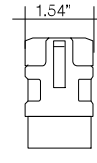
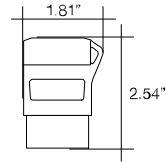
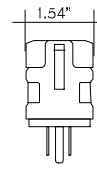
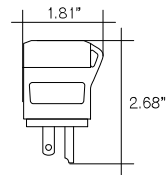



Reference	Color	Description
0-1115	Orange & Black Naranja/Negro	15 Amp, 125 V Grounded Plug, Rugged PC, Moisture Resistant, Chemicals and Impact. 15 Amp, 125 V, Enchufe con Polo a Tierra, PC Robusto. Resistente a la Humedad, Químicos e Impacto.



0-1115-R	Orange & Black Naranja/Negro	15 Amp, 125 V Grounded Plug, Rugged PC + Rubber Grip, Chemicals and Impact. 15 Amp, 125 V, Enchufe con Polo a Tierra, PC Robusto + Agarr de Goma, Resistente a la Humedad, Químicos e Impacto.
----------	---------------------------------	---



0-2115	Orange & Black Naranja/Negro	15 Amp, 125 V Grounded Connector, Rugged PC, Moisture Resistant, Chemicals and Impact. 15 Amp, 125 V, Hembra con Tierra, PC Resistente, Resister a la Humedad, Químicos e Impacto
--------	---------------------------------	--



0-2115-R	Orange & Black Naranja/Negro	15 Amp, 125 V Grounded Connector, Rugged PC + Rubber Grip, Moisture Resistant, Chemicals and Impact. 5 Amp, 125 V, Hembra con Tierra, PC Resistente + Agarre e Goma, Resistente a la Humedad, Químicos e Impacto.
----------	---------------------------------	--



0-1120	Orange & Black Naranja/Negro	20 Amp, 125 V Grounded Plug, Rugged PC, Moisture Resistant, Chemicals and Impact. 20 Amp, 250 V, Enchufe con Polo a Tierra, PC Robusto, ente a la Humedad, Químicos e Impacto.
--------	---------------------------------	---



0-1120-R	Orange & Black Naranja/Negro	20 Amp, 125 V Grounded Plug, Rugged PC + Rubber Grip, Moisture Resistant, Chemicals and Impact. 20 Amp, 250 V, Enchufe con Polo a Tierra, PC Robusto + Agarre de Goma, Resistente a la Humedad, Químicos e Impacto.
----------	---------------------------------	--



0-2120	Orange & Black Naranja/Negro	20 Amp, 125 V Grounded Connector, Rugged PC, Moisture Resistant, Chemicals and Impact. 20 Amp, 250 V, Hembra con Tierra, PC Resistente + Agarre Goma. Resistente a la Humedad, Químicos e Impacto.
--------	---------------------------------	---



0-2120-R	Orange & Black Naranja/Negro	20 Amp, 125 V Grounded Connector, Rugged PC + Rubber Grip, Moisture Resistant, Chemicals and Impact. 20 Amp, 250 V, Hembra con Tierra, PC Resistente + Agarre Goma. Resistente a la Humedad, Químicos e Impacto.
----------	---------------------------------	---

Reference	Color	Description
0-1001	White Blanco	<p>15 Amp, 125 V, Residential Grade, Polarized, Non-Grounding Plug, Straight Blade, Screw Assembly.</p> <p>15 Amp, 125 V, Residencial, Polarizado, Sin Tierra. Cuchilla Recta, Ensamble con Tornillo.</p>
0-1001-N	Black Negro	<p>15 Amp, 125 V, Residential Grade, Polarized, Non-Grounding Plug, Straight Blade, Screw Assembly.</p> <p>15 Amp, 125 V, Residencial, Polarizado, Sin Tierra. Cuchilla Recta, Ensamble con Tornillo.</p>
0-2001	White Blanco	<p>15 Amp, 125 V, Residential Grade, Polarized, Non-Grounding Connector, Straight Blade, Screw Assembly.</p> <p>15 Amp, 125 V, Residencial, Polarizado, Sin Tierra. Cuchilla Recta, Ensamble con Tornillo.</p>
0-2001-N	Black Negro	<p>15 Amp, 125 V, Residential Grade, Polarized, Non-Grounding Connector, Straight Blade, Assembly Screw.</p> <p>15 Amp, 125 V, Residencial, Polarizado, Sin Tierra. Cuchilla Recta, Ensamble con Tornillo.</p>
0-1101	White Blanco	<p>15 Amp, 125 V, Residential Grade, Polarized, Grounded Plug, Straight Blade, Screw Assembly.</p> <p>15 Amp, 125 V, Residencial, Polarizado, Con Tierra, Recta, Ensamble con Tornillo.</p>
0-1101-N	Black Negro	<p>15 Amp, 125 V, Residential Grade, Polarized, Grounded Plug, Straight Blade, Screw Assembly.</p> <p>15 Amp, 125 V, Residencial, Polarizado, Con Tierra, Recta, Ensamble con Tornillo.</p>
0-2101	White Blanco	<p>15 Amp, 125 V, Residential Grade, Polarized, Grounded Connector, Straight Blade, Screw Assembly.</p> <p>15 Amp, 125 V, Residencial, Polarizado, Con Tierra, Cuchilla, Recta, Ensamble con Tornillo.</p>
0-2101-N	Black Negro	<p>15 Amp, 125 V, Residential Grade, Polarized, Grounded Connector, Straight Blade, Screw Assembly.</p> <p>15 Amp, 125 V, Residencial, Polarizado, Con Tierra, Cuchilla, Recta, Ensamble con Tornillo.</p>

Travel Adapters

Adaptadores de viaje



Your perfect travel partner. With this adapter you will be able to use and charge your devices while traveling.

Note: This is just a plug adapter that changes the pins, it will not convert voltage.

Su compañero perfecto para viajes, con este adaptador puedes mantener tus accesorios cargados.

*Nota: Este accesorio es solo un adaptador que convierte los pines de la clavija, no convierte el voltaje.

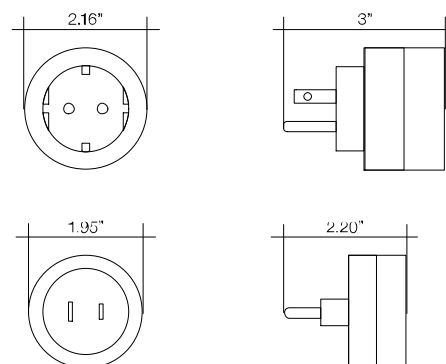

Reference	Color	Description
0-1417	White Blanco	15 Amp, 250 V, American USA to European Plug Adapter. 15 Amp, 250 V, de toma Americana a toma Europea.
0-1416	White Blanco	6 Amp, 250 V, European Plug Adapter to American USA. 6 Amp, 250 V. de toma Europea a toma Americana.

MÁXIMA ESTANQUEIDAD IP68
MAXIMUM SEALING IP68

easylife ConnectPLUS

EASY LIFE
TECH
by famatel
USA

IP68



Kit incluye / Kit include

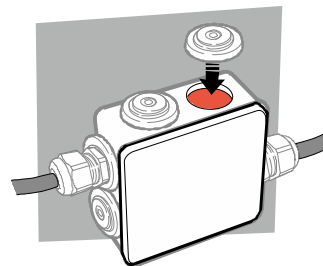
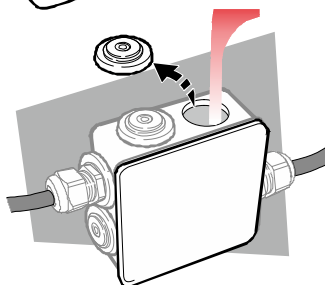
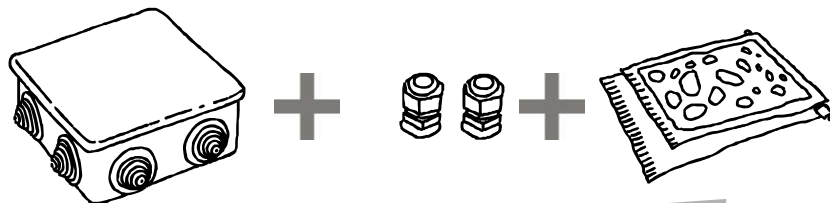

Ref.	3002-GL
Connect Plus	80x80mm 3"35/64 x 3"35/64



Para más información descargar
video de instalación
For further information download
the installation video



Ceramic Grill Tiles

Placas Cerámicas para Barbacoa



Configurable to any grill size

Configurable a cualquier tamaño de parrilla



Reduce Flare Ups.
Reduce Cold Spots.
Enhance BBQ Flavor.
Snap Technique to Modify Tile Size.
Reduce Gas Consumption.
Covers up to 270 square inches of grill area.

Reduce las Llamaradas.
Reduce los Puntos Fríos.
Mejora el Sabor a BBQ.
Placas Configurables a Cualquier Tamaño de Parrilla.
Reduce el Consumo de Gas.
Cubre hasta 270 pulgadas cuadradas de la superficie de su parrilla.

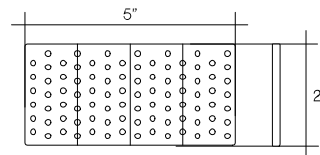

Reference
Referencia

Color
Color

Description
Descripción

K-BBQ

White
Blanco

15 Ceramic Grill Tiles, Covers 270 Square Inches.
15 Placas de Cerámica, Cubren 270 Pulgadas Cuadradas.



famatel
 USA

EASY LIFE
TECH

1241 Stirling Road, Unit 118
Dania Beach, FL 33004
United States of America
Tel. + 1 754 217 4841
info@famatelusa.com
www.famatelusa.com
www.easylifeproduct.com